

rfRXD0420 Receiver Module

*Author: Steven Bible
Microchip Technology Inc.*

INTRODUCTION

The rfRXD0420 Receiver Module (see Figure 1) is a low cost, high performance UHF short-range radio ASK receiver design using the Microchip Technology rfRXD0420.

FIGURE 1: rfRXD0420 RECEIVER MODULE

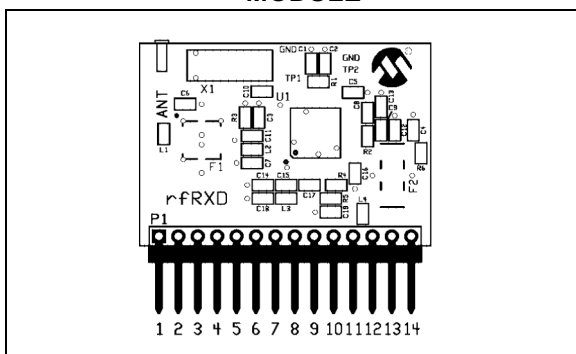

The module design is suitable for:

- Wireless remote command and control
- Remote Keyless Entry (RKE)
- Security systems
- Low power telemetry applications

The specifics of the receiver module design are:

- Single channel, fixed frequency at 315 MHz and 433.92 MHz
- ASK modulation
- Signal rate: 4800 baud

Schematics, PCB layout, and Bill-of-Materials (BOM) are provided in the following sections. Gerber files are available on the rfPIC™ Development Kit 1 CD-ROM.

The receiver module can be purchased separately or in packs of 5. See Table 1

TABLE 1: RECEIVER MODULE ORDERING INFORMATION

	Order Number	
Frequency	Single	5 Pack
315 MHz	AC164104	AC164106
433.92 MHz	AC164103	AC164105

rfRXD0420 DESCRIPTION

The rfRXD0420 is a stand-alone receiver module that can be used in a variety of ways.

- It can be plugged into the PICKit™ 1 FLASH Starter Kit expansion header J3 for demonstration and development.
- The receiver module can be installed in any project for proof-of-concept, demonstration, or development purposes. Once project proof-of-concept and demonstration have been proven, the designer can use the available Gerber files or complete a design of their own.

A detailed description of the rfRXD0420 UHF ASK/FSK/FM Receiver is provided in the data sheet, DS70090.

A detailed description of the rfRXD0420 receiver module design is provided in application note, AN860.

Table 2 lists the pinout for the rfRXD0420 receiver

TABLE 2: rfRXD0420 RECEIVER MODULE PINOUT

Pin	Description
1-10	No Connection
11	Receive Data In
12	No Connection
13	Power: 2.5-5.5 VDC
14	Ground
ANT	Antenna Connection

TB070

The antenna connection is a 0.055 inch pin receptacle. A simple small diameter wire (AWG 24) antenna can be constructed and inserted into the receptacle. The length of the wire depends on the frequency.

$$\lambda \text{ (meters)} = c / f \text{ (Hertz)}$$

where

$$c = 3 \times 10^8 = \text{speed of light (meters per second)}$$

$$f = \text{receive frequency (Hertz)}$$

$$\lambda = \text{wavelength (meters)}$$

The length of the antenna wire in inches can be found for a given frequency using the following formula:

$$\text{wire antenna length (inches)} = 2952.8 / f \text{ (MHz)}$$

Alternatively, the pin receptacle can be removed and an alternate antenna connection can be made. For example, a coaxial wire can be connected to the antenna pad on the front side of the PCB and ground pad on the back side of the PCB.

PCB LAYOUT

The following figures illustrate the various layers of the rFRXD0420 receiver module printed circuit board.

FIGURE 2: rFRXD0420 TOP SILK-SCREEN

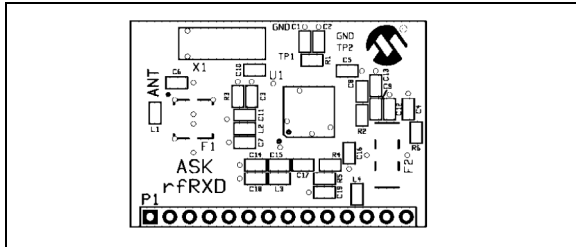

FIGURE 3: rFRXD0420 TOP COPPER

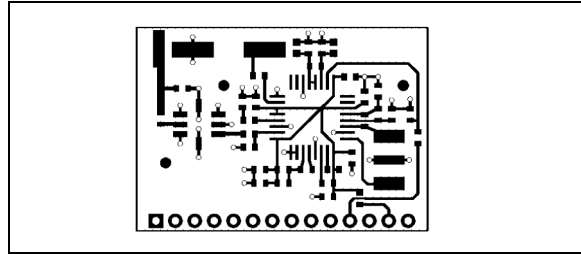
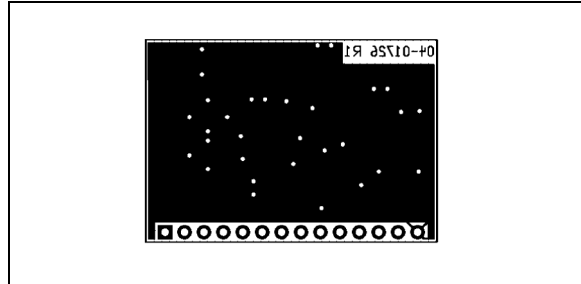

FIGURE 4: rFRXD0420 BOTTOM COPPER



GERBER FILES

Gerber Files for the rFRXD0420 are available on the rPIC Development Kit 1 CD-ROM.

rFRXD0420 SCHEMATIC

Figure 5 is a detailed schematic of the rFRXD0420 module.

FIGURE 5: rFRXD0420 RECEIVER MODULE

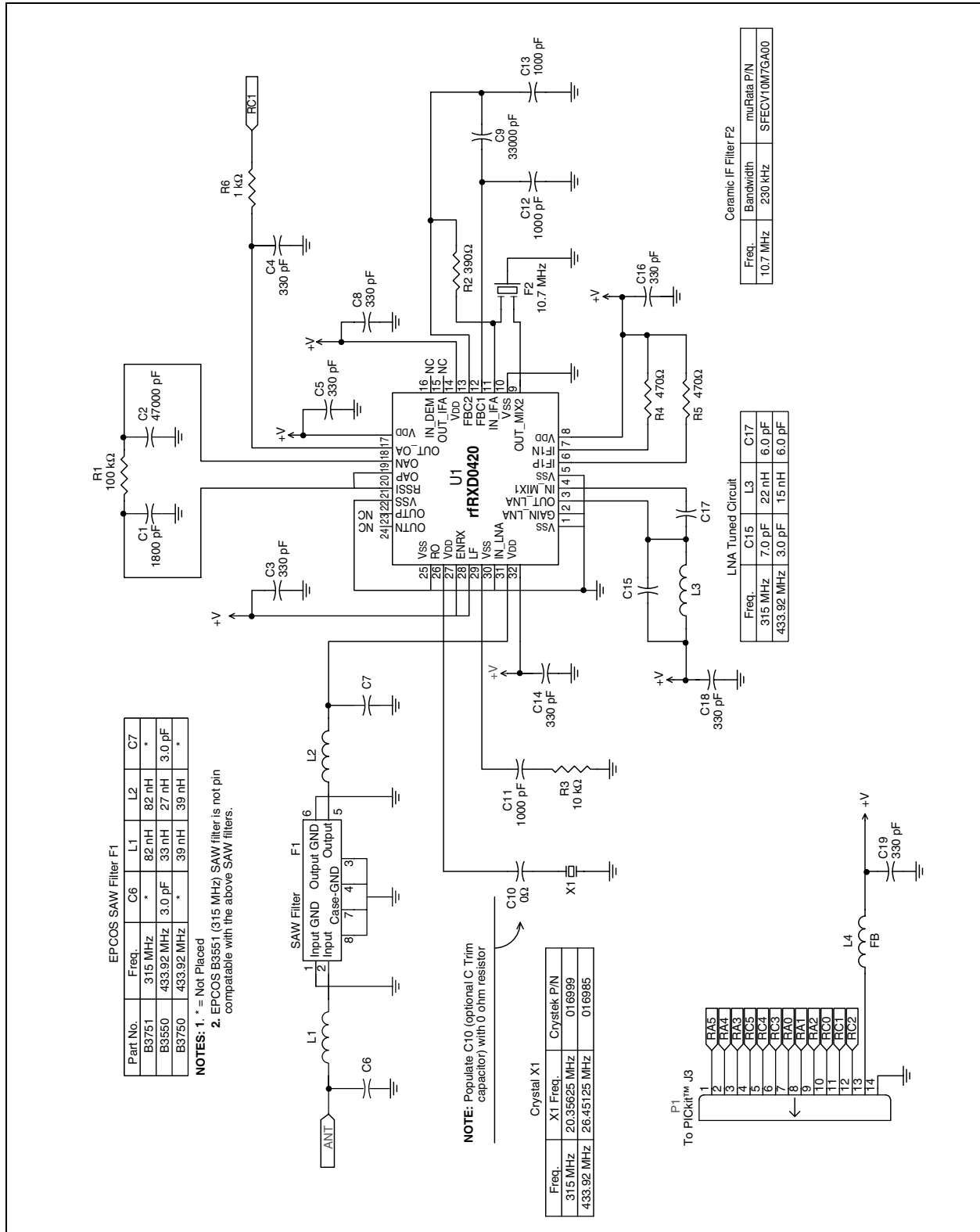

FIGURE 6: rFRXD0420 RECEIVER MODULE BILL-OF-MATERIALS

rFRXD0420 Receiver Module Bill-of-Materials						
Quantity	Designator	Value	Description	Order From	Part Number	
2	C6, C7	Not Placed				
1	C15 - 433.92 MHz	3 pF, NP0, 0603	Capacitor, Ceramic Chip	Digi-Key	PCC030CVTR-ND	
1	C17	6 pF, NP0, 0603	Capacitor, Ceramic Chip	Digi-Key	PCC060CVTR-ND	
1	C15 - 315 MHz	7 pF, NP0, 0603	Capacitor, Ceramic Chip	Digi-Key	PCC070CVTR-ND	
8	C3, C4, C5, C8, C14, C16, C18, C19	330 pF, X7R, 0603	Capacitor, Ceramic Chip	Digi-Key	PCC331ACVTR-ND	
3	C11, C12, C13	1000 pF, X7R, 0603	Capacitor, Ceramic Chip	Digi-Key	PCC1772TR-ND	
1	C1	1800 pF, X7R, 0603	Capacitor, Ceramic Chip	Digi-Key	PCC1775TR-ND	
1	C9	33000 pF, X7R, 0603	Capacitor, Ceramic Chip	Digi-Key	PCC1769TR-ND	
1	C2	47000 pF, X5R, 0603	Capacitor, Ceramic Chip	Digi-Key	PCC1771TR-ND	
1	C10	0 ohm, 0603	Resistor, Chip, Thick Film	Digi-Key	P0.0GTR-ND	
1	R2	390 ohm, 0603	Resistor, Chip, Thick Film	Digi-Key	P390GTR-ND	
2	R4, R5	470 ohm, 0603	Resistor, Chip, Thick Film	Digi-Key	P470GTR-ND	
1	R6	1K ohm	Resistor, Chip, Thick Film	Digi-Key	P1.0KGTR-ND	
1	R3	10K ohm, 0603	Resistor, Chip, Thick Film	Digi-Key	P10KGTR-ND	
1	R1	100K ohm, 0603	Resistor, Chip, Thick Film	Digi-Key	P100KGTR-ND	
1	L3 - 315 MHz	22 nH, 0603	Inductor, Chip	Digi-Key	TKS3715TR-ND	
1	L3 - 433.92 MHz	15 nH, 0603	Inductor, Chip	Digi-Key	TKS3713TR-ND	
2	L1, L2 - 315 MHz	82 nH, 0603	Inductor, Chip	Digi-Key	TKS3722TR-ND	
2	L1, L2 - 433.92 MHz	39 nH, 0603	Inductor, Chip	Digi-Key	TKS3718TR-ND	
1	L4	600Z, 0603	Ferrite Bead Chip	Digi-Key	240-1143-2-ND	
1	P1	14-Pin Right Angle Header	Single row 0.025" square right angle post	Digi-Key	A26510-ND	
1	F1 - 315 MHz		SAW Filter - 315 MHz	EPCOS	B3751	
1	F1 - 433.92 MHz		SAW Filter - 433.92 MHz	EPCOS	B3750	
1	F2		10.7 MHz Ceramic Filter, 230 kHz BW	muRata	SFECV10M7GA00	
1	X1 - 315 MHz	20.35625 MHz	Crystal, HC-49/S	Crystek	016999	
1	X1 - 433.92 MHz	26.451250 MHz	Crystal, HC-49/S	Crystek	016985	
1	U1	rFRXD0420	UHF ASK/FSK/FM Receiver	Microchip	rFRXD0420	

THIRD PARTY COMPONENT SUPPLIERS

Crystek Crystal Corporation

12730 Commonwealth Drive
Fort Myers, FL 33913
Toll Free: 1-800-237-3061
Phone: 1-239-561-3311
Fax: 1-239-561-1025
E-mail: salesdept@crystek.com
Internet: <http://www.crystek.com>

Murata Electronics North America, Inc.

Corporate Headquarters
2200 Lake Park Drive
Smyrna, GA 30080-7604
Phone: 1-770-436-1300
Fax: 1-770-436-3030
Internet: <http://www.murata-northamerica.com>

EPCOS, Inc.

186 Wood Avenue South
Iselin, NJ 08830
Phone: 1-732-906-4300
Fax: 1-732-603-5935
E-Mail: sales.usa@epcos.com
Internet: <http://www.usa.epcos.com>

TB070

NOTES:

Note the following details of the code protection feature on Microchip devices:

- Microchip products meet the specification contained in their particular Microchip Data Sheet.
- Microchip believes that its family of products is one of the most secure families of its kind on the market today, when used in the intended manner and under normal conditions.
- There are dishonest and possibly illegal methods used to breach the code protection feature. All of these methods, to our knowledge, require using the Microchip products in a manner outside the operating specifications contained in Microchip's Data Sheets. Most likely, the person doing so is engaged in theft of intellectual property.
- Microchip is willing to work with the customer who is concerned about the integrity of their code.
- Neither Microchip nor any other semiconductor manufacturer can guarantee the security of their code. Code protection does not mean that we are guaranteeing the product as "unbreakable."

Code protection is constantly evolving. We at Microchip are committed to continuously improving the code protection features of our products. Attempts to break microchip's code protection feature may be a violation of the Digital Millennium Copyright Act. If such acts allow unauthorized access to your software or other copyrighted work, you may have a right to sue for relief under that Act.

Information contained in this publication regarding device applications and the like is intended through suggestion only and may be superseded by updates. It is your responsibility to ensure that your application meets with your specifications. No representation or warranty is given and no liability is assumed by Microchip Technology Incorporated with respect to the accuracy or use of such information, or infringement of patents or other intellectual property rights arising from such use or otherwise. Use of Microchip's products as critical components in life support systems is not authorized except with express written approval by Microchip. No licenses are conveyed, implicitly or otherwise, under any intellectual property rights.

Trademarks

The Microchip name and logo, the Microchip logo, KEELOQ, MPLAB, PIC, PICmicro, PICSTART, PRO MATE and PowerSmart are registered trademarks of Microchip Technology Incorporated in the U.S.A. and other countries.

FilterLab, microID, MXDEV, MXLAB, PICMASTER, SEEVAL and The Embedded Control Solutions Company are registered trademarks of Microchip Technology Incorporated in the U.S.A.

Accuron, Application Maestro, dsPIC, dsPICDEM, dsPICDEM.net, ECONOMONITOR, FanSense, FlexROM, fuzzyLAB, In-Circuit Serial Programming, ICSP, ICEPIC, microPort, Migratable Memory, MPASM, MPLIB, MPLINK, MPSIM, PICC, PICkit, PICDEM, PICDEM.net, PowerCal, PowerInfo, PowerMate, PowerTool, rLAB, rPIC, Select Mode, SmartSensor, SmartShunt, SmartTel and Total Endurance are trademarks of Microchip Technology Incorporated in the U.S.A. and other countries.

Serialized Quick Turn Programming (SQTP) is a service mark of Microchip Technology Incorporated in the U.S.A.

All other trademarks mentioned herein are property of their respective companies.

© 2003, Microchip Technology Incorporated, Printed in the U.S.A., All Rights Reserved.

 Printed on recycled paper.

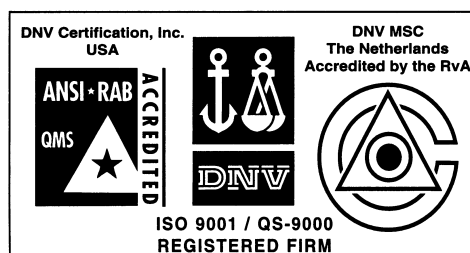

Microchip received QS-9000 quality system certification for its worldwide headquarters, design and wafer fabrication facilities in Chandler and Tempe, Arizona in July 1999 and Mountain View, California in March 2002. The Company's quality system processes and procedures are QS-9000 compliant for its PICmicro® 8-bit MCUs, KEELOQ® code hopping devices, Serial EEPROMs, microperipherals, non-volatile memory and analog products. In addition, Microchip's quality system for the design and manufacture of development systems is ISO 9001 certified.



WORLDWIDE SALES AND SERVICE

AMERICAS

Corporate Office

2355 West Chandler Blvd.
Chandler, AZ 85224-6199
Tel: 480-792-7200 Fax: 480-792-7277
Technical Support: 480-792-7627
Web Address: <http://www.microchip.com>

Atlanta

3780 Mansell Road, Suite 130
Alpharetta, GA 30022
Tel: 770-640-0034 Fax: 770-640-0307

Boston

2 Lan Drive, Suite 120
Westford, MA 01886
Tel: 978-692-3848 Fax: 978-692-3821

Chicago

333 Pierce Road, Suite 180
Itasca, IL 60143
Tel: 630-285-0071 Fax: 630-285-0075

Dallas

4570 Westgrove Drive, Suite 160
Addison, TX 75001
Tel: 972-818-7423 Fax: 972-818-2924

Detroit

Tri-Atria Office Building
32255 Northwestern Highway, Suite 190
Farmington Hills, MI 48334
Tel: 248-538-2250 Fax: 248-538-2260

Kokomo

2767 S. Albright Road
Kokomo, IN 46902
Tel: 765-864-8360 Fax: 765-864-8387

Los Angeles

18201 Von Karman, Suite 1090
Irvine, CA 92612
Tel: 949-263-1888 Fax: 949-263-1338

Phoenix

2355 West Chandler Blvd.
Chandler, AZ 85224-6199
Tel: 480-792-7966 Fax: 480-792-4338

San Jose

Microchip Technology Inc.
2107 North First Street, Suite 590
San Jose, CA 95131
Tel: 408-436-7950 Fax: 408-436-7955

Toronto

6285 Northam Drive, Suite 108
Mississauga, Ontario L4V 1X5, Canada
Tel: 905-673-0699 Fax: 905-673-6509

ASIA/PACIFIC

Australia

Microchip Technology Australia Pty Ltd
Marketing Support Division
Suite 22, 41 Rawson Street
Epping 2121, NSW
Australia
Tel: 61-2-9868-6733 Fax: 61-2-9868-6755

China - Beijing

Microchip Technology Consulting (Shanghai)
Co., Ltd., Beijing Liaison Office
Unit 915
Bei Hai Wan Tai Bldg.
No. 6 Chaoyangmen Beidajie
Beijing, 100027, No. China
Tel: 86-10-85282100 Fax: 86-10-85282104

China - Chengdu

Microchip Technology Consulting (Shanghai)
Co., Ltd., Chengdu Liaison Office
Rm. 2401-2402, 24th Floor,
Ming Xing Financial Tower
No. 88 TIDU Street
Chengdu 610016, China
Tel: 86-28-86766200 Fax: 86-28-86766599

China - Fuzhou

Microchip Technology Consulting (Shanghai)
Co., Ltd., Fuzhou Liaison Office
Unit 28F, World Trade Plaza
No. 71 Wusi Road
Fuzhou 350001, China
Tel: 86-591-7503506 Fax: 86-591-7503521

China - Hong Kong SAR

Microchip Technology Hongkong Ltd.
Unit 901-6, Tower 2, Metroplaza
223 Hing Fong Road
Kwai Fong, N.T., Hong Kong
Tel: 852-2401-1200 Fax: 852-2401-3431

China - Shanghai

Microchip Technology Consulting (Shanghai)
Co., Ltd.
Room 701, Bldg. B
Far East International Plaza
No. 317 Xian Xia Road
Shanghai, 200051
Tel: 86-21-6275-5700 Fax: 86-21-6275-5060

China - Shenzhen

Microchip Technology Consulting (Shanghai)
Co., Ltd., Shenzhen Liaison Office
Rm. 1812, 18/F, Building A, United Plaza
No. 5022 Binhe Road, Futian District
Shenzhen 518033, China
Tel: 86-755-82901380 Fax: 86-755-8295-1393

China - Qingdao

Rm. B505A, Fullhope Plaza,
No. 12 Hong Kong Central Rd.
Qingdao 266071, China
Tel: 86-532-5027355 Fax: 86-532-5027205

India

Microchip Technology Inc.
India Liaison Office
Marketing Support Division
Divyasree Chambers
1 Floor, Wing A (A3/A4)
No. 11, O'Shaughnessy Road
Bangalore, 560 025, India
Tel: 91-80-2290061 Fax: 91-80-2290062

Japan

Microchip Technology Japan K.K.
Benex S-1 6F
3-18-20, Shinyokohama
Kohoku-Ku, Yokohama-shi
Kanagawa, 222-0033, Japan
Tel: 81-45-471-6166 Fax: 81-45-471-6122

Korea

Microchip Technology Korea
168-1, Youngbo Bldg. 3 Floor
Samsung-Dong, Kangnam-Ku
Seoul, Korea 135-882
Tel: 82-2-554-7200 Fax: 82-2-558-5934

Singapore

Microchip Technology Singapore Pte Ltd.
200 Middle Road
#07-02 Prime Centre
Singapore, 188980
Tel: 65-6334-8870 Fax: 65-6334-8850

Taiwan

Microchip Technology (Barbados) Inc.,
Taiwan Branch
11F-3, No. 207
Tung Hua North Road
Taipei, 105, Taiwan
Tel: 886-2-2717-7175 Fax: 886-2-2545-0139

EUROPE

Austria

Microchip Technology Austria GmbH
Durisolstrasse 2
A-4600 Wels
Austria
Tel: 43-7242-2244-399
Fax: 43-7242-2244-393

Denmark

Microchip Technology Nordic ApS
Regus Business Centre
Lautrup høj 1-3
Ballerup DK-2750 Denmark
Tel: 45-4420-9895 Fax: 45-4420-9910

France

Microchip Technology SARL
Parc d'Activite du Moulin de Massy
43 Rue du Saule Trapu
Batiment A - Ier Etage
91300 Massy, France
Tel: 33-1-69-53-63-20 Fax: 33-1-69-30-90-79

Germany

Microchip Technology GmbH
Steinheilstrasse 10
D-85737 Ismaning, Germany
Tel: 49-89-627-144-0
Fax: 49-89-627-144-44

Italy

Microchip Technology SRL
Via Quasimodo, 12
20025 Legnano (MI)
Milan, Italy
Tel: 39-0331-742611 Fax: 39-0331-466781

United Kingdom

Microchip Ltd.
505 Eskdale Road
Wokingham
Wokingham
Berkshire, England RG41 5TU
Tel: 44-118-921-5869 Fax: 44-118-921-5820

05/30/03