



T-49-19-08

PIC1654S

8-Bit Microcontroller

FEATURES

- 32 8-bit RAM registers
- 512 x 12-bit program ROM
- Arithmetic Logic Unit
- Real Time Clock/Counter
- Self contained oscillator for crystal or ceramic resonator
- Access to RAM registers inherent to instruction
- Available in three temperature ranges: 0° to 70°C, -40° to 85°C and -40° to 110°C
- 18 pin package
- 2 level stack for subroutine nesting
- Open drain option on all I/O lines
- 12 bi-directional I/O lines
- 2 µsec instruction execution time

PIN CONFIGURATION

18 Lead Dual In Line
18 Lead SOIC

Top View

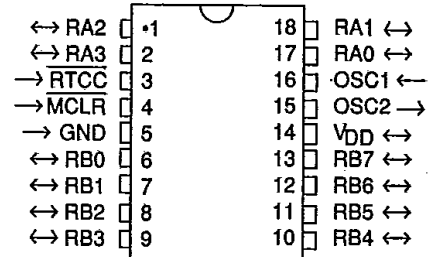

DESCRIPTION

The PIC1654S microcontroller is a MOS/LSI device containing RAM, I/O, and a central processing unit as well as customer-defined ROM on a single chip. This combination produces a low cost solution for applications which require sensing individual inputs and controlling individual outputs. Keyboard scanning, display driving, and other system control functions can be done at the same time due to the power of the 8-bit CPU.

The internal ROM contains a customer-defined program using the PIC's powerful instruction set to specify the overall functional characteristics of the device. The 8-bit input/output registers provide latched lines for interfacing to a limitless variety of applications. The PIC can be used to scan keyboards, drive displays, control electronic games and provide enhanced capabilities for motor control, telecommunication equipment, radios, television, consumer appliances, industrial timing and control applications. The 12-bit instruction word format provides a powerful yet easy to use instruction repertoire emphasizing single bit manipulation as well as logical and arithmetic operations using bytes.

The PIC1654S is fabricated with N-Channel Silicon Gate technology resulting in a high performance product with proven reliability and production history. Only a single wide range power supply is required for operation, and an on-chip oscillator provides the operating clock with an external crystal or ceramic resonator to establish the frequency. Inputs and outputs are TTL-compatible.

Extensive hardware and software support is available to aid the user in developing an application program and to verify performance before committing to mask tooling. Programs can be assembled into machine language using PICALC, a powerful macroassembler. PICALC is available in various versions that can be run on many popular computer systems. Once the application program is developed several options are available to insure proper performance. The PICES II real time In-Circuit Emulation System, PIC Field Demo boards (PFD), and the ROM-less version of the PIC1654S, the PIC1664, provide all required development and debugging tools.

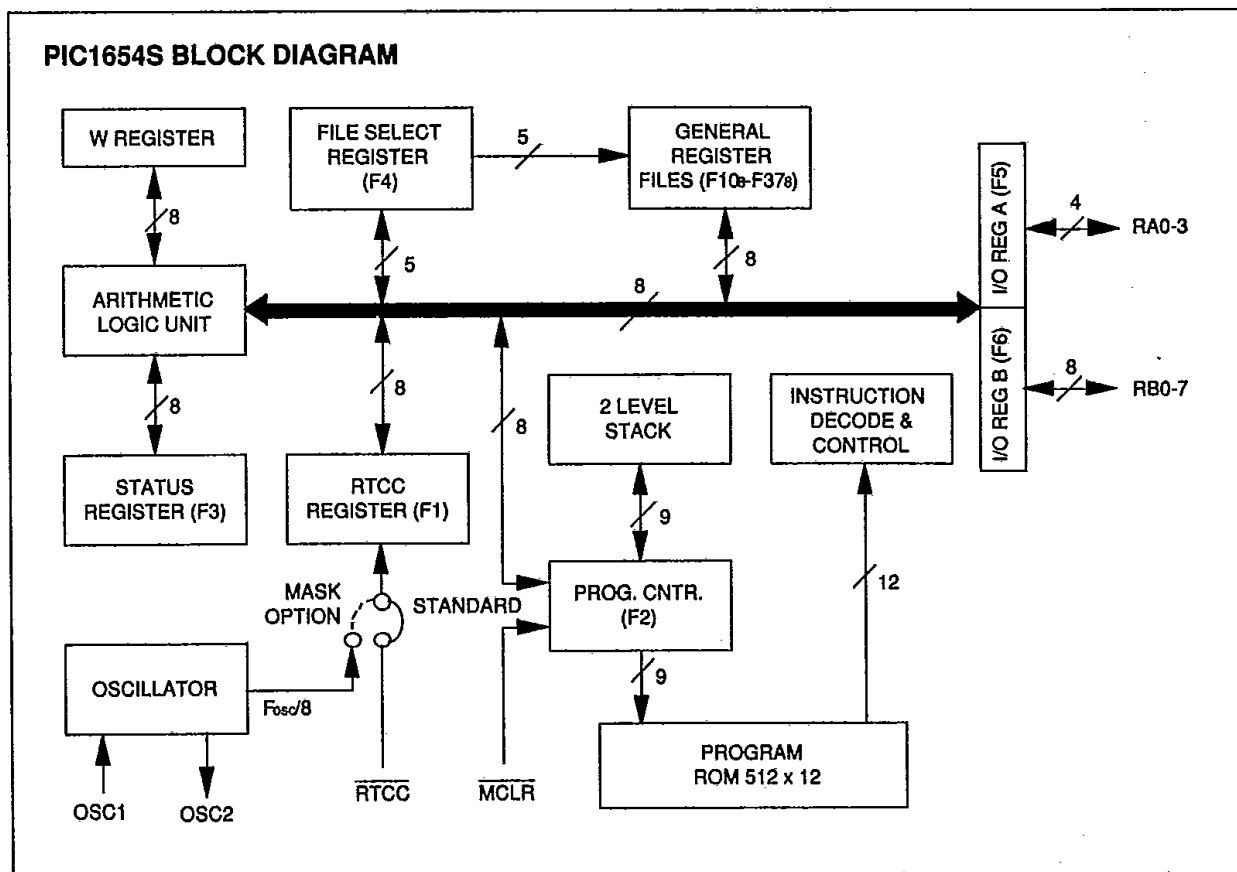

ARCHITECTURAL DESCRIPTION

The firmware architecture of the PIC series microcontroller is based on a register file concept with simple yet powerful commands designed to emphasize bit, byte, and register transfer operations. The instruction set also supports computing functions as well as these control and interface functions.

Internally, the PIC is composed of three functional elements connected together by a single bidirectional bus: the Register File composed of 32 addressable 8-bit registers, an Arithmetic Logic Unit, and a user-defined Program ROM composed of 512 words each 12 bits in width. The Register File is divided into two functional groups: operational registers and general registers. The operational registers include, among others, the Real Time Clock/Counter (RTCC), the Program Counter (PC), the Status Register, and the I/O Registers. The general purpose registers are used for data and control information under command of the instructions.

The Arithmetic Logic Unit contains one temporary working register (W Register) and gating to perform Boolean functions between data held in the working register and any file register.

The Program ROM contains the operational program for the rest of the logic within the controller. Sequencing of microinstructions is controlled via the Program Counter (PC) which automatically increments to execute in-line programs. Program control operations can be performed by Bit Test and Skip instructions, Jump instructions, Call instructions, or by loading computed addresses into the PC. In addition, an on-chip two-level stack is employed to provide easy to use subroutine nesting. Activating the MCLR input on power up initializes the ROM program to address 777_h.

T-49-19-08

PIN FUNCTION TABLE	
Signal	Definition
OSC1 (Input), OSC2 (Output)	These pins are the time base inputs to which a crystal, ceramic resonator, or external single phase clock may be connected. The frequency of oscillation is 8 times the instruction cycle frequency.
$\overline{\text{RTCC}}$ (Input)	Real Time Clock/Counter. Used by the microprogram to keep track of elapsed time between events. The Real Time Clock/Counter Register increments on falling edges applied to this pin. This register (F1) can be loaded and read by the program. This is a Schmitt trigger input. A mask option will allow an internal clock signal whose period is equal to the instruction execution time to drive the real time clock counter register. In this mode, transitions in the RTCC pin will be disregarded. However, the pin must be tied to either Vss or VDD to avoid unintended test mode activation.
RA0-3 (Input/Output)	4 user programmable I/O lines (F5). The four MSB's are always read as logic 0's. All inputs and outputs are under direct control of the program. A mask option will allow any I/O pin at the time of ROM pattern definition to be open drain.
RB0-7 (Input/Output)	8 user programmable I/O lines (F6). All inputs and outputs are under direct control of the program. A mask option will allow any I/O pin at the time of ROM pattern definition to be open drain.
$\overline{\text{MCLR}}$ (Input)	Master Clear. Used to initialize the internal ROM program to address 777h and latch all I/O registers high. Should be held low 10 - 75ms past the time when VDD \geq 4.5V depending on the crystal start up time. This is a Schmitt trigger input.
VDD	Power supply.
Vss	Ground pin.

T-49-19-08

REGISTER FILE ARRANGEMENT																	
File (Octal)	Function																
F0	Not a physically implemented register. F0 calls for the contents of the File Select Register (low order 5 bits) to be used to select a file register. F0 is thus useful as an indirect address pointer. For example, $W + F0 \rightarrow W$ will add the contents of the file register pointed to by the FSR (F4) to W and place the result in W.																
F1	Real Time Clock/Counter Register. This register can be loaded and read by the microprogram. The RTCC register <u>keeps</u> counting up after zero is reached. The counter increments on high-to-low transitions on the RTCC input. However, if <u>data</u> is being stored in the RTCC register simultaneously with a negative transition on the RTCC pin, the RTCC register will contain the new stored value and the external transition will be ignored by the microcomputer.																
F2	Program Counter (PC). The nine bit wide PC is automatically incremented during each instruction cycle, unless it is written into under program control (MOVWF F2, GOTO, CALL, ADDWF F2, RETLW). CALL, MOVWF2, ADDWF2 instructions write only the 8 low order bits of the PC, while the MSB is made to zero. Only the 8 low order bits of F2 can be read under program control.																
F3	Status Word Register. F3 can be altered under program control only via bit set, bit clear, or MOVWF F3 instruction. <table style="margin-left: auto; margin-right: auto; border-collapse: collapse;"> <tr> <td style="padding: 0 10px;">(7)</td> <td style="padding: 0 10px;">(6)</td> <td style="padding: 0 10px;">(5)</td> <td style="padding: 0 10px;">(4)</td> <td style="padding: 0 10px;">(3)</td> <td style="padding: 0 10px;">(2)</td> <td style="padding: 0 10px;">(1)</td> <td style="padding: 0 10px;">(0)</td> </tr> <tr> <td style="border: 1px solid black; text-align: center;">1</td> <td style="border: 1px solid black; text-align: center;">1</td> <td style="border: 1px solid black; text-align: center;">1</td> <td style="border: 1px solid black; text-align: center;">1</td> <td style="border: 1px solid black; text-align: center;">1</td> <td style="border: 1px solid black; text-align: center;">Z</td> <td style="border: 1px solid black; text-align: center;">DC</td> <td style="border: 1px solid black; text-align: center;">C</td> </tr> </table> <p>C (Carry): For ADD and SUB instructions, this bit is set if there is a carry out from the most significant bit of the resultant. For ROTATE instructions, this bit is loaded with either the high or low order bit of the source.</p> <p>DC (Digit Carry): For ADD and SUB instructions, this bit is set if there is a carry out from the 4th low order bit of the resultant. Note that a subtraction is always executed as an addition of the two's complement of the second operand.</p> <p>Z (Zero): Set if the result of an Arithmetic operation is zero. Bits: 3-7 These bits are defined as logic ones.</p>	(7)	(6)	(5)	(4)	(3)	(2)	(1)	(0)	1	1	1	1	1	Z	DC	C
(7)	(6)	(5)	(4)	(3)	(2)	(1)	(0)										
1	1	1	1	1	Z	DC	C										
F4	File Select Register (FSR). Low order 5 bits only are used. The FSR is used in generating effective file register addresses under program control. When accessed as a directly addressed file, the upper 3 bits are read as ones.																
F5	I/O Register A (RA0-RA3) (RA4 - RA7 defined as zeros).																
F6	I/O Register B (RB0-RB7).																
F7-F37h	General Purpose Registers.																

T-49-19-08

BASIC INSTRUCTION SET SUMMARY

Each PIC instruction is a 12-bit word divided into an OP code that specifies the instruction type and one or more operands specifying the operation of the instruction. The following PIC instruction summary lists byte-oriented, bit-oriented, and literal and control operations.

For byte-oriented instructions, "f" represents a file register designator and "d" represents a destination designator. The file register designator specifies which one of the 32 PIC file registers is to be utilized by the instruction. The destination designator specifies where the result of the operation performed by the instruction is to be placed. If "d" is zero, the result is placed in the PIC W register. If "d" is one, the result is returned to the file register specified in the instruction.

For bit oriented instructions, "b" represents a bit field designator that selects the number of the bit affected by the operation, while "f" represents the number of the file in which the bit is located.

For literal and control operations, "k" represents an eight- or nine-bit constant or literal value.

For an oscillator frequency of 4MHz the instruction execution time is 2 μ sec, unless a conditional test is true or the program counter is changed as a result of an instruction*. In these two cases, the instruction execution time is 4 μ sec.

* (GOTO, CALL, RETLW, MOVWF2, ADDWF2).

BYTE-ORIENTED FILE REGISTER					(11-6)	(5)	(4-0)
For d = 0, f \rightarrow W (PIC16 accepts d = 0 or d = W in the mnemonic)					OP CODE	d	f(FILE #)
d = 1, f \rightarrow f (if d is omitted, assembler assigns d = 1).							
Instruction-Binary (Octal)	Name	Mnemonic, Operands	Operation	Status Affected			
000 000 000 000 (0000)	No Operation	NOP - -	-	None			
000 000 1ff fff (0040)	Move W to f (Note 1)	MOVWF - W \rightarrow f		None			
000 001 000 000 (0100)	Clear W	CLRW - 0 \rightarrow W		Z			
000 001 1ff fff (0140)	Clear f	CLRF f 0 \rightarrow f		Z			
000 010 dff fff (0200)	Subtract W from f	SUBWF f,d f-W \rightarrow d [f + \overline{W} + 1 \rightarrow d]		C,DC,Z			
000 011 dff fff (0300)	Decrement f	DECf f,d f-1 \rightarrow d		Z			
000 100 dff fff (0400)	Inclusive OR W and f	IORWF f,d Wvf \rightarrow d		Z			
000 101 dff fff (0500)	ANDbW and f	ANDWF f,d W \cdot f \rightarrow d		Z			
000 110 dff fff (0600)	Exclusive OR W and f	XORWF f,d W \oplus f \rightarrow d		Z			
000 111 dff fff (0700)	Add W and f	ADDWF f,d W + F \rightarrow d		C,DC,Z			
001 000 dff fff (1000)	Move f	MOVF f,d f \rightarrow d		Z			
001 001 dff fff (1100)	Complement f	COMF f,d f \rightarrow d		Z			
001 011 dff fff (1200)	Increment f	INCF f,d f + 1 \rightarrow d		Z			
001 011 dff fff (1300)	Decrement f, Skip if Zero	DECFSZ f,d f - 1 \rightarrow d, skip if Zero		None			
001 100 dff fff (1400)	Rotate Right f	RRF f,d f(n) \rightarrow d(n-1), C \rightarrow d(7), f(0) \rightarrow C		C			
001 101 dff fff (1500)	Rotate Left f	RLF f,d f(n) \rightarrow d(n+1), C \rightarrow d(0), f(7) \rightarrow C		C			
001 110 dff fff (1600)	Swap halves f	SWAPF f,d f(0-3) \leftrightarrow f(4-7) \rightarrow d		None			
001 111 dff fff (1700)	Increment f, Skip if Zero	INCFSZ f,d f + 1 \rightarrow d, skip if Zero		None			

T-49-19-08

BIT-ORIENTED FILE REGISTER OPERATIONS					(11-8)		(7-5)	(4-0)
					OP CODE		b (BIT #)	f (FILE #)
Instruction-Binary (Octal)					Name	Mnemonic, Operands	Operation	Status Affected
010	0bb	bff	fff	(2000)	Bit Clear f	BCF f,b	0→f(b)	None
010	1bb	bff	fff	(2400)	Bit Set f	BSF f,b	1→f(b)	None
011	0bb	bff	fff	(3000)	Bit Test f, skip if Clear	BTFSC f,b	Bit Test f(b): skip if clear	None
011	1bb	bff	fff	(3400)	Bit Test f, skip if Set	BTFSS f,b	Bit Test f(b): skip if set	None

LITERAL AND CONTROL OPERATIONS					(11-8)		(7-0)	
					OP CODE		k (LITERAL)	
Instruction-Binary (Octal)					Name	Mnemonic, Operands	Operation	Status Affected
100	0kk	kkk	kkk	(4000)	Return and place Literal in W	RETLW k	k→w, Stack→PC	None
100	1kk	kkk	kkk	(4400)	Call subroutine (Note 1)	CALL k	PC+1-Stack, k→PC	None
101	kkk	kkk	kkk	(5000)	Go to address (k is 9 bits)	GOTO k	k→PC	None
110	0kk	kkk	kkk	(6000)	Move Literal to W	MOVLW k	k→W	None
110	1kk	kkk	kkk	(6400)	Inclusive OR Literal and W	IORLW k	k∨W→W	Z
111	0kk	kkk	kkk	(7000)	AND Literal and W	ANDLW k	k∧W→W	Z
111	1kk	kkk	kkk	(7400)	Exclusive OR Literal and W	XORLW k	k⊕W→W	Z

NOTES:

1. The 9th bit of the program counter in the PIC is zero for a CALL and a MOVWF F2. Therefore, subroutines must be located in program memory locations 0-3778. However, subroutines can be called from anywhere in the program memory since the Stack is 9 bits wide.
2. When an I/O register is modified as a function of itself, the value used will be that value present on the output pins. For example, an output pin which has been latched high but is driven low by an external device, will be relatched in the low state.

T-49-19-08

SUPPLEMENTAL INSTRUCTION SET SUMMARY

The following supplemental instructions summarized below represent specific applications of the basic PIC instructions. For example, the "CLEAR CARRY" supplemental instruction is equivalent to the basic instruc-

tion BCF 3.0 ("Bit Clear, File 3, Bit 0"). These instruction mnemonics are recognized by the PIC Cross Assembler (PICAL).

SUPPLEMENTAL INSTRUCTION SET SUMMARY				
Instruction-Binary (Octal)	Name	Mnemonic, Operands	Operation	Status Affected
010 000 000 011 (2003)	Clear Carry	CLRC	BCF 3, 0	-
010 100 000 011 (2403)	Set Carry	SETC	BSF 3, 0	-
010 000 100 011 (2043)	Clear Digit Carry	CLRDC	BCF 3, 1	-
010 100 100 011 (2443)	Set Digit Carry	SETDC	BSF 3, 1	-
010 001 000 011 (2103)	Clear Zero	CLRZ	BCF 3, 2	-
010 101 000 011 (2503)	Set Zero	SETZ	BSF 3, 2	-
011 100 000 011 (3403)	Skip on Carry	SKPC	BTFSS 3, 0	-
011 000 000 011 (3003)	Skip on No Carry	SKPNC	BTFSC3, 0	-
011 100 100 011 (3443)	Skip on Digit Carry	SKPDC	BTFSS 3, 1	-
011 000 100 011 (3043)	Skip on No Digit Carry	SKPNDC	BTFSC 3,1	-
011 101 000 011 (3503)	Skip on Zero	SKPZ	BTFSS 3, 2	-
011 001 000 011 (3103)	Skip on No Zero	SKPNZ	BTFSC3, 2	-
001 000 1ff fff (1040)	Test File	TSTF f	MOVF f, 1	Z
001 000 0ff fff (1000)	Move File to W	MOVFW f	MOVF f, 0	Z
001 001 1ff fff (1140)	Negate File	NEGF f,d	COMF f, 1	-
001 010 dff fff (1200)	-	-	NCFf,d	Z
011 000 000 011 (3003)	Add Carry to File	ADD0CF f,d	BTFSC 3,0	-
001 010 dff fff (1200)	-	-	INCF f,d	Z
011 000 000 011 (3003)	Subtract Carry from File	SUB0CF f,d	BTFSC 3, 0	-
000 011 dff fff (0300)	-	-	DECF f,d	Z
011 000 100 011 (3043)	Add Digit Carry to File	ADD0DCF f,d	BTFSG 3, 1	-
001 010 dff fff (1200)	-	-	INCF f,d	Z
011 000 100 011 (3043)	Subtract Digit Carry from File	SUB0DCF f,d	BTFSC 3, 1	-
000 011 dff fff (0300)	-	-	DECF f,d	Z
101 kkk kkk kkk (5000)	Branch	B k	GOTO k	-
011 000 000 011 (3003)	Branch on Carry	BC k	BTFSC 3, 0	-
101 kkk kkk kkk (5000)	-	-	GOTO k	-
011 100 000 011 (3403)	Branch on No Carry	BNC k	BTFSS 3, 0	-
101 kkk kkk kkk (5000)	-	-	GOTO k	-
011 100 100 011 (3043)	Branch on Digit Carry	BDC k	BTFSC 3, 1	-
101 kkk kkk kkk (5000)	-	-	GOTO k	-
011 001 000 011 (3443)	Branch on No Digit Carry	BNDC k	BTFSS 3, 1	-
101 kkk kkk kkk (5000)	-	-	GOTO k	-
011 101 000 011 (3103)	Branch on Zero	BZ k	BTFSC 3, 2	-
101 kkk kkk kkk (5000)	-	-	GOTO k	-
011 101 000 011 (3503)	Branch on No Zero	BNZ k	BTFSS 3, 2	-
101 kkk kkk kkk (5000)	-	-	GOTO k	-

PIC1654S*T-49-19-08***I/O INTERFACING**

The equivalent circuit for an I/O port bit is shown below as it would interface with either the input of a TTL device (PIC is outputting) or the output of an open collector TTL device (PIC is inputting). Each I/O port bit can be individually time multiplexed between input and output functions under software control. When outputting through a PIC I/O Port, the data is latched at the port and

the pin can be connected directly to a TTL gate input. When inputting data through an I/O Port, the port latch must first be set to a high level under program control. This turns off Q_2 , allowing the TTL open collector device to drive the pad, pulled up by Q_1 , which can source a minimum of $100\mu\text{A}$. Care, however, should be exercised when using open collector devices due to the potentially high TTL leakage current which can exist in the high logic state.

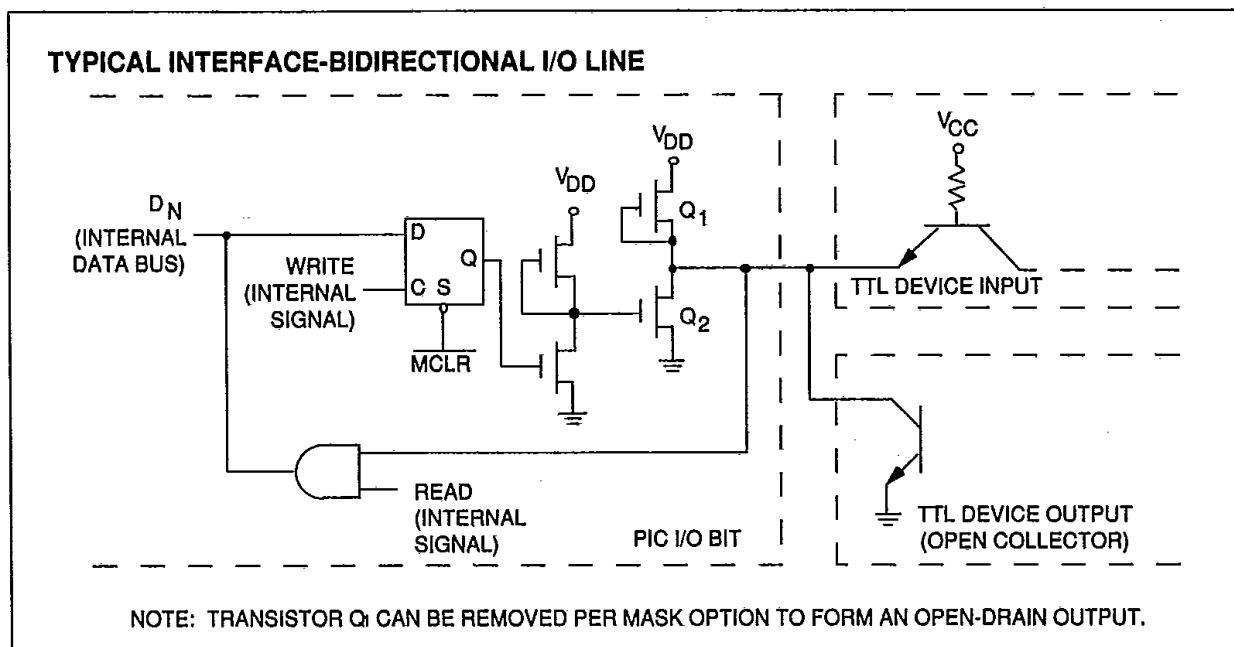
**PROGRAMMING CAUTIONS**

The use of the bidirectional I/O ports are subject to certain rules of operation. These rules must be carefully followed in the instruction sequences written for I/O operation.

BIDIRECTIONAL I/O PORTS

The bidirectional ports may be used for both input and output operations. For input operations these ports are non-latching. Any input must be present until read by an input instruction. The outputs are latched and remain unchanged until the output latch is rewritten. For use as an input port the output latch must be set in the high state. Thus the external device inputs to the PIC circuit by forcing the latched output line to the low state or keeping the latched output high. This principle is the same whether operating on individual bits or the entire port.

Some instructions operate internally as input followed by output operations. The BCF and BSF instructions, for example, read the entire port into the CPU, execute the bit operation, and re-output the result. Caution must be used when using these instructions. As an example a BSF operation on bit 5 of F6 (port RB) will cause all eight bits of F6 to be read into the CPU. Then the BSF operation takes place on bit 5 and F6 is re-output to the output latches. If another bit of F6 is used as an input (say bit 0) then bit 0 must be latched high. If during the BSF instruction on bit 5 an external device is forcing bit 0 to the low state then the input/output nature of the BSF instruction will leave bit 0 latched low after execution. In this state bit 0 cannot be used as an input until it is again latched high by the programmer. Refer to the examples on the next page.

T-49-19-08

Successive Operations on Bidirectional I/O Ports

Care must be exercised if successive instructions operate on the same I/O port. The sequence of instructions should be such to allow the pin voltage to stabilize (load dependent) before the next instruction which causes

that file to be read into the CPU (MOVF, BIT SET, BIT CLEAR, and BIT TEST) is executed. Otherwise, the previous state of that pin may be read into the CPU rather than the new state. This will happen if t_{pd} (See I/O Timing Diagram) is greater than $1/4t_{cy}$ (min). When in doubt, it's better to separate these instructions with a NOP or other instruction.

EXAMPLE 1

What is thought to be happening:
BSF 6,5

Read into CPU: 00001111
Set bit 5: 00101111
Write to F6: 00101111

If no inputs were low during the instruction execution, there would be no problem.

EXAMPLE 2

What could happen if an input were low:
BSF 6,5

Read into CPU: 00001110
Set bit 5: 00101110
Write to F6: 00101110

In this case bit 0 is now latched low and is no longer useful as an input until set high again.

PIC1654S

T-49-19-08

ELECTRICAL CHARACTERISTICS

Maximum Ratings*

Ambient temperature under bias.....	125°C
Storage Temperature	-55°C to +150°C
Voltage on any pin with respect to V _{SS} (except open drain)	-0.3V to +9.0V
Voltage on any pin with respect to V _{SS} (open drain)	-0.3V to +13V
Power Dissipation (Note 1)	800mW

* Exceeding these ratings could cause permanent damage to the device. This is a stress rating only and functional operation of this device at these conditions is not implied. Operating ranges are specified in Standard Conditions. Exposure to absolute maximum rating conditions for extended periods may affect device reliability.

Data labeled "typical" is presented for design guidance only and is not guaranteed.

DC CHARACTERISTICS - PIC16C54S						
Operating temperature TA = 0°C to +70°C						
Characteristic	Sym	Min	Typ†	Max	Units	Conditions
Power Supply Voltage	V _{DD}	4.5	-	7.0	V	All I/O pins @ V _{DD} (See Primary Supply Current Chart for additional information).
Primary Supply Current	I _{DD}	-	30	50	mA	
Input Low Voltage	V _{IL}	-0.2	-	0.8	V	(Note 4) I _{OH} = -100µA provided by internal pullups (Note 2) I _{OL} = -1.6mA, (Note 3)
Input High Voltage (except MCLR, RTCC & OSC1)	V _{IH}	2.4	-	V _{DD}	V	
Input High Voltage (MCLR, RTCC & OSC1)	V _{IH2}	V _{DD} - 1	-	V _{DD}	V	
Output High Voltage	V _{OH}	2.4	-	V _{DD}	V	
Output Low Voltage (I/O only)	V _{OL1}	-	-	0.45	V	
Input RTCC Current	I _{RTCC}	-	7	20	µA	V _{SS} ≤ V _{IN} ≤ V _{DD}
Input Leakage Current (MCLR)	I _{IC}	-5	-	+5	µA	V _{SS} ≤ V _{IN} ≤ V _{DD}
Output Leakage Current (open drain pins)	I _{OL}	-	-	10	µA	V _{SS} ≤ V _{PIN} ≤ 12V
Input Low Current (all I/O ports)	I _{IL}	-0.2	-	-1.6	mA	V _{IL} = 0.4V (internal pullup)
Input High Current (all I/O ports)	I _{IH}	-0.1	-0.4	-	mA	V _{IH} = 2.4V

† Typical data is at TA = 25°C, V_{DD} = 5.0V.

NOTES:

- Total power dissipation for the package is calculated as follows:
 $P_D = (V_{DD}) (I_{DD}) + \sum (V_{DD} - V_{IL}) (I_{OHI}) + \sum (V_{OL}) (I_{OL})$
 The term I/O refers to all interface pins; input, output or I/O.
- Positive current indicates current into pin.
 Negative current indicates current out of pin.
- Total I_{OL} for all output pins must not exceed 175 mA.
- Instantaneous voltage on the RTCC and MCLR input must not exceed V_{DD} + 1V otherwise the test mode may be entered. If the RTCC pin is not used in an application it must be tied to V_{SS} or V_{DD}.

PIC1654S

T-49-19-08

DC CHARACTERISTICS-PIC1654S-I

Operating temperature TA = -40°C to + 85°C

Characteristic	Sym	Min	Typ†	Max	Units	Conditions
Power Supply Voltage	VDD	4.5	-	7.0	V	All I/O pins @ VDD (See Primary Supply Current Chart for additional information).
Primary Supply Current	IDD	-	30	54	mA	
Input Low Voltage	VIL	-0.2	-	0.8	V	(Note 4) IOH = -100µA provided by internal pullups (Note 2) IOL = -1.6mA (Note 3)
Input High Voltage (except MCLR, RTCC & OSC1)	VIH	2.4	-	VDD	V	
Input High Voltage (MCLR, RTCC & OSC1)	VIH2	VDD - 1	-	VDD	V	
Output High Voltage	VOH	2.4	-	VDD	V	
Output Low Voltage (I/O only)	VOL1	-	-	0.45	V	
Input RTCC Current	IRTCC	-	7	20	µA	VSS ≤ VIN ≤ VDD
Input Leakage Current (MCLR)	ILC	-5	-	+5	µA	VSS ≤ VIN ≤ VDD
Output Leakage Current (open drain pins)	IOL	-	-	10	µA	VSS ≤ VPIN ≤ 9V
Input Low Current (all I/O ports)	IIL	-0.2	-	-1.6	mA	VIL = 0.4V (internal pullup)
Input High Current (all I/O ports)	IIH	-0.1	-0.4	-	mA	TA = 0°C to 85°C VIH = 2.4V

† Typical data is at TA = 25°C, VDD = 5.0V.

NOTES:

- Total power dissipation for the package is calculated as follows:

$$PD = (VDD)(IDD) + \sum(VDD - VIL)(IIL) + \sum(VDD - VOH)(IOH) + \sum(VOL)(IOL)$$
- Positive current indicates current into pin.
 Negative current indicates current out of pin.
- Total IOL for all output pins must not exceed 175 mA.
- Instantaneous voltage on the RTCC and MCLR input must not exceed VDD + 1V otherwise the test mode may be entered. If the RTCC pin is not used in an application, it must be tied to VSS or VDD.

PIC1654S

T-49-19-08

DC CHARACTERISTICS - PIC1654S-H						
Operating temperature TA = -40°C to + 110°C						
Characteristic	Sym	Min	Typ†	Max	Units	Conditions
Power Supply Voltage	VDD	4.5	-	5.5	V	All I/O pins @ VDD (See Primary Supply Current Chart for additional information).
Primary Supply Current	IDD	-	35	58	mA	
Input Low Voltage	VIL	-0.2	-	0.8	V	(Note 4) IOH = -100µA provided by internal pullups (Note 2) IOL = -1.6mA (Note 3) VSS ≤ VIN ≤ VDD VSS ≤ VIN ≤ VDD VSS ≤ VPIN ≤ 9V
Input High Voltage (except MCLR, RTCC & OSC1)	VIH	2.4	-	VDD	V	
Input High Voltage (MCLR, RTCC & OSC1)	VIH2	VDD - 1	-	VDD	V	
Output High Voltage	VOH	2.4	-	VDD	V	
Output Low Voltage (I/O only)	VOL1	-	-	0.45	V	VIL = 0.4V(internal pullup) TA = 0°C to 110°C VIH = 2.4V
Input RTCC Current	IRTCC	-	7	20	µA	
Input Leakage Current (MCLR)	ILC	- 5	-	+ 5	µA	
Output Leakage Current (open drain I/O pins)	IOL	-	-	20	µA	
Input Low Current (all I/O ports)	IIL	- 0.2	-	-1.6	mA	
Input High Current (all I/O ports)	IIH	- 0.1	-0.4	-	mA	

† Typical data is at TA = 25°C, VDD = 5.0V.

NOTES:

- Total power dissipation for the package is calculated as follows:

$$P_D = (V_{DD})(I_{DD}) + \sum(V_{DD} - V_{IL})(I_{IIL}) + \sum(V_{DD} - V_{OH})(I_{IOH}) + \sum(V_{OL})(I_{OL})$$
- Positive current indicates current into pin. Negative current indicates current out of pin.
- Total IOL for all output pins must not exceed 17 5mA.
- Instantaneous voltage on the RTCC and MCLR input must not exceed VDD + 1V otherwise the test mode may be entered. If the RTCC pin is not used in an application, it must be tied to Vss or VDD.

T-49-19-08

AC CHARACTERISTICS - PIC1654S

Operating temperature TA = 0°C to + 70°C
 -40°C to +85°C and -40°C to + 110°C

Characteristic	Sym	Min	Typ	Max	Units	Conditions
Instruction Cycle Time	tCY	2	-	10	μs	0.8 MHz - 4.0MHz external time base (Notes 1 and 2)
RTCC Input Period	tRT	tCY = 0.2μs-	-	-	-	Note 3
High Pulse Width	tRTH	1/2 tRT	-	-	-	
Low Pulse Width	tRTL	1/2 tRT	-	-	-	

NOTES:

1. Instruction cycle period (tCY) equals eight times the input oscillator time base period.
2. The oscillator frequency may deviate to 4.08MHz to allow for tolerance of a crystal or ceramic resonator time base element.
3. The maximum frequency which may be input to the RTCC pin is calculated as follows:

$$f_{(max)} = \frac{1}{t_{RT (min)}} = \frac{1}{t_{CY (min)} + 0.2\mu s}$$

For example: if tCY = 4μs, f(max) = $\frac{1}{4.2\mu s} = 238\text{KHz}$.

RTCC TIMING

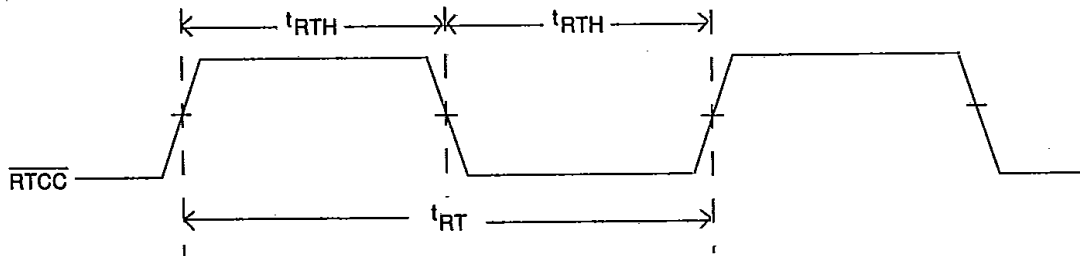

PIC1654S

T-49-19-08

OSCILLATOR OPTIONS (TYPICAL CIRCUITS) (Cont.)

CRYSTAL INPUT OPERATION

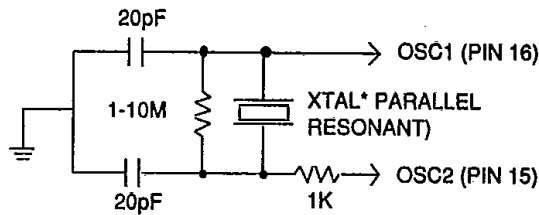

* Or ceramic resonator

EXTERNAL CLOCK INPUT OPERATION

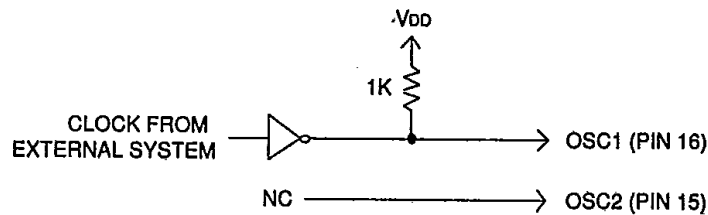

PRIMARY SUPPLY CURRENT AT SELECTED TEMPERATURES

Characteristic	Sym	PIC1654S PIC1654S-I		PIC1654S-H		Units	Conditions
		Typ	Max	Typ	Max		
Primary Supply Current	IDD	40	54	48	58	mA	-40°C, All I/O pins at VDD
		35	50	44	54	mA	0°C, All I/O pins at VDD
		24	45	39	49	mA	70°C, All I/O pins at VDD
		22	42	36	46	mA	85°C, All I/O pins at VDD
		-	-	30	40	mA	110°C, All I/O pins at VDD

T-49-19-08

MASTER CLEAR (TYPICAL CIRCUIT)

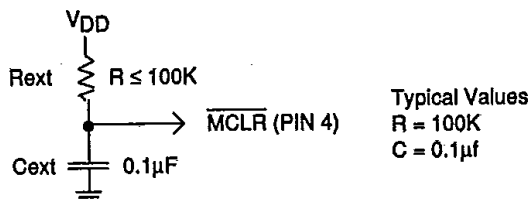

The $\overline{\text{MCLR}}$ pin must be pulsed low for a minimum of one complete instruction cycle (t_{CY}) for the master clear function to be guaranteed, assuming that power is applied and the oscillator is running. For initial power application, a delay is required for the external oscillator time base element to start up before $\overline{\text{MCLR}}$ is brought high. To achieve this, an external RC configuration, as shown, can be used. This provides approximately a 10ms delay (assuming V_{DD} is applied as a step function), which may be insufficient for some time base elements. Consult the manufacturer of the time base element for the specific start-up times.

OUTPUT SINK CURRENT GRAPH (TYPICAL)

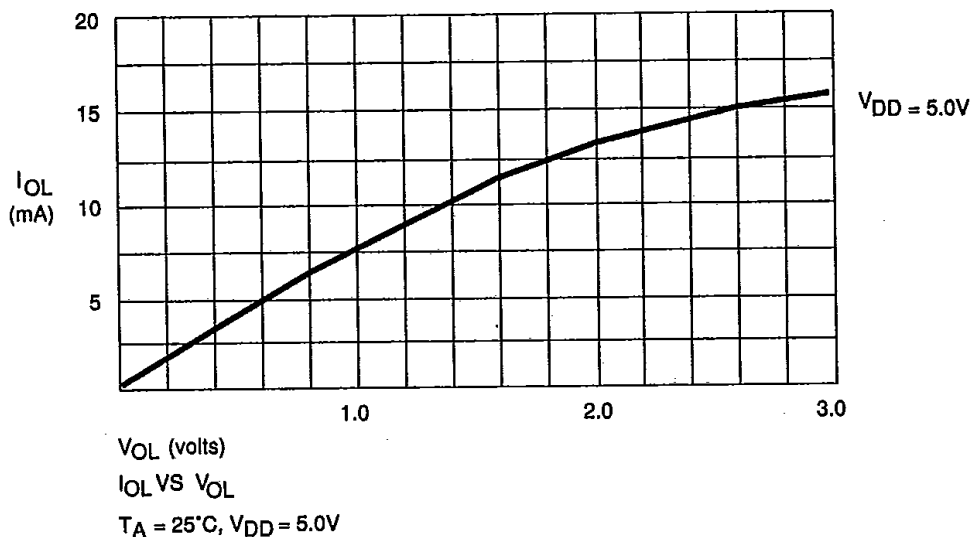

T-49-19-08

SALES AND SUPPORT

To order or to obtain information, e.g., on pricing or delivery, please use the listed part numbers, and refer to the factory or the listed sales offices.

PART NUMBERS

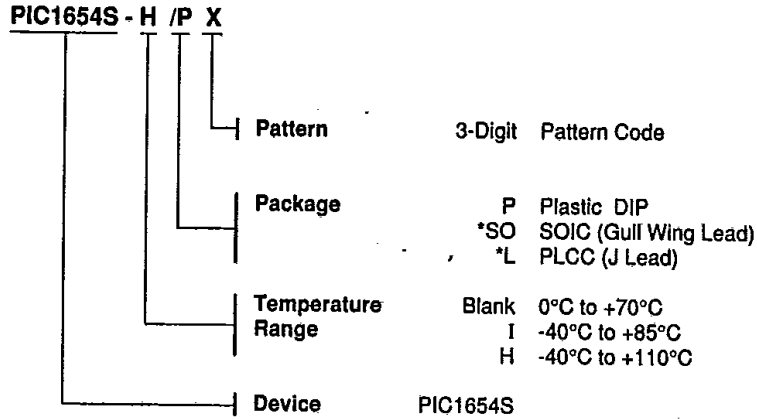

Notes: *SOIC and PLCC available in Commercial Temperature (0°C to +70°C) only