



A Real-Time Operating System for PICmicro™ Microcontrollers

*Author: Jerry Farmer
Myriad Development Company*

INTRODUCTION

Ever dream of having a Real-Time Kernel for the PIC16CXXX family of microcontrollers? Or ever wonder what Multitasking or Threads are all about? Then this article is for you. We will explore how to implement all of the features of a large Real-Time Multitasking Kernel in much less space, with more control, and without the large overhead of existing kernels. By planning ahead, and using the techniques outlined here, you can build your own fast, light, powerful, flexible real-time kernel with just the features needed to get the job done.

Included in this article are two large examples: one on the PIC16C54, and the other on the more powerful PIC16C64. A "Remote Alarm" is implemented on the PIC16C54 as an example of a Non-Preemptive Kernel, with two asynchronous serial input sources capable of running up to 19,200 Baud along with seven sensors needing to be debounced as inputs. One more input line is monitored and causes an internal software recount. For output, this example has an LED that shows eight different internal states of the "Remote Alarm", blinking at different rates and different sequences. Last but not least, is an asynchronous serial output capable of running at 38,400 Baud, passing the inputs to the next remote alarm station. Several short and long timers are included to round out the nine cooperating tasks in this example. Please refer to Figure 2 and Appendix B.

The second example is implemented on an PIC16C64 featuring an interrupt driven Semi-Preemptive Kernel. This example has the serial input and output routines of the first example moved into Interrupt Service Routines (ISR) for more speed and accuracy. The interrupt capabilities of the PIC16C64 will be explored, and a Real-Time Multitasking Kernel framework will be developed. Please refer to Figure 5 and Appendix C.

Why do I Need a Real-Time Kernel?

Real-time design techniques allow the engineer/designer to break-up large, complicated problems into smaller simpler tasks or threads. These more manageable units of code allow faster response to important events, while prioritizing the jobs to be done in a structured well-tested format. The kernel does the job of keeping the time, the peace between tasks, and keeping all the tasks' communication flowing. More activities can be performed in the same amount of time by allowing other tasks to work while other tasks are waiting for some event to occur. Smaller code is also the result of using State-Driven techniques because much information is condensed into the state variables and code structure. If you need an example, look at the PIC16C54's "Remote Alarm" code.

What is Multitasking Anyway?

This is the appearance of several tasks working at the same time. Each task thinks that it owns the CPU, but this appearance is controlled by the kernel. Only one task can be running at a time, but there is undone work that can be done by other tasks not blocked. Multitasking is the orchestration of interrupts, events, communication, shared data, and timing to get a job done. Real-Time Programming is just a bunch of ideas, concepts, and techniques that allow us to divide problems into units of code that are based on units of time, or events that drive a task from one state to another.

CONCEPTS

We will cover the basic concepts of kernels here so that we are using the same definitions when talking about this difficult topic. This article is a very quick survey on Real-Time Kernel concepts. I hope to get you thinking, reading more, and hopefully writing RT Operating Systems for your current and future projects. Many great books have been written about this very broad and interesting subject. We will refer to some of these books which have a different point of view other than those expressed in this paper.

Critical Section

A critical section is a shared data structure, or a shared resource, or a critical time section of code, or a non-reentrant section of code that can have only one owner that is allowed to view/change/use that section at any one time. These sections must not be interrupted during the update process. They must be protected so that other tasks can not get in and change the pointers/data or modify the hardware at the same time. Remember that if two tasks can get into a critical section, at the same time, then data WILL be corrupted. Make sure that critical sections are small, with time for pending interrupts to get serviced. Not understanding critical sections is where the beginning RT programmers get into the most trouble. Even without interrupts, you must protect variables that are changing over time, such as the byte sized variable `xmt_byte` used in the PIC16C54 example. This variable changes each time the STATE changes for the Serial Out Task. Semaphores, and Disabling Interrupts are two of the techniques used to coordinate between different tasks wanting to control a critical section. Task #4 is devoted to the proper feeding of the shared Serial Out Resource in the PIC16C54 example. Note the use of the binary semaphore "OState_B" to control Task #4, Task #1, and the variable `xmt_byte`. There are several more examples of critical sections in the PIC16C64 example due to the use of interrupts. We disable interrupts for very short time periods to protect these areas. Also in the PIC16C64 example, all critical sections are finished before checking to see if the kernel wants another task to start running instead of the current task. We will discuss in more detail how to protect critical sections later in this article.

FIGURE 1: TASK / PROCESS STATE TRANSITION DIAGRAM

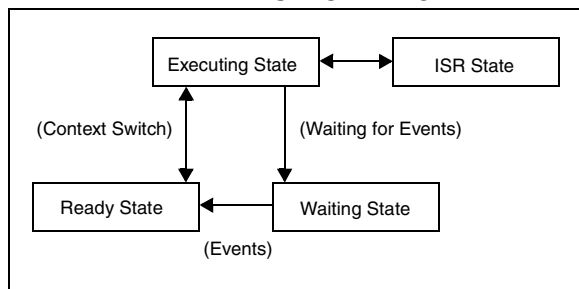

Shared Resources

Data structures, displays, I/O hardware, and non-reentrant routines are a few resource examples. If two or more tasks use these resources, then they are called Shared Resources and you must protect them from being corrupted. They must have only one owner, a way of telling others to wait, and possibly a waiting list for future users of that resource. A rare example of a shared resource is when there exists a critical timing sequence of input and output operations to control some hardware. You must disable interrupts before starting this sequence, and re-enable them upon finishing. Note that Task #1 in the PIC16C64 example is an example of a "non-reentrant" routine that must be finished by the current owner before another task can use it.

Context Switch/Task Switch

When one task takes over from another, the current values of the CPU registers for this running task are saved and the old saved registers for the new task are restored. The new task continues where it left off. This is all done by the Context Switch part of the Real-Time Kernel. Each task usually has a "context switch storage area". Each task's SP (Stack Pointer pointing into its own stack) is stored there along with all the other important saved registers. The "Remote Alarm" example does not need to use a context switch because all the important registers are properly freed-up before each task is finished. The PIC16C64 example uses a similar concept, thus keeping the number of saved registers per task way down. We use an old concept called "where I came from". The variable "FROM" is used to direct the dispatcher to start up the task where it left off. This is because you cannot manipulate the stack in the PIC16CXXX family. This same reason is why we have a "Semi-Preemptive" kernel on the PIC16C64 as an example. By the way, the faster the context switch is done, the better.

Scheduler

The scheduler is that part of the kernel that decides which task will run next. We will talk about several common types in this section. This is where a lot of thinking should be done before starting your new project. By understanding the different kinds of schedulers and what features and problems each type has, you can match your problem to a creatively styled scheduler that meets your needs. For example, the PIC16C54 example shows the recalling of Tasks #1-3 just before a long sequence of code is executed. More creative ways can also be implemented, but be careful to allow all tasks to execute in a timely fashion.

Please see Figure 1. Each task must be in "Ready State" or the "Executing State" to be considered by the scheduler to get temporary control of the CPU next.

Non-Preemptive Kernel

The Non-Preemptive Kernel is also called a “Cooperative Kernel” because the tasks only give-up control when they want/need to in coordination with other tasks, and events. The “Remote Alarm” example uses a Non-Preemptive Kernel type, showing that despite its reputation as being a simple kernel type, a lot can be done with it. The Non-Preemptive Kernel type is well suited for the non-interrupt type PIC16C5Xs. The heart beat of the PIC16C54 example is the internal TMR0 counter crossing over from a high value to a low value of the counter. Use the prescaler to adjust the time units. The very fast tasks continually read the TMR0 directly comparing the delta of time to see if it should fire.

Preemptive Kernel

In a Preemptive Kernel, a running task can be swapped out for a higher priority task when it becomes ready. The Preemptive Kernel relies much more on interrupts as its driving force. The context switch is at the heart of this type of kernel. To implement a true Preemptive Kernel, you must be able to manipulate the stack. This is why we implemented a “Semi-Preemptive” kernel on the PIC16C64, with some of the best features of both types of kernels. We moved some of the tasks in the PIC16C54 example into ISRs to handle the I/Os. This works very well as the ISRs are very short and do most of the real work in this example. The TIMER0 interrupt is the heart beat for the PIC16C64 example. You must have a clock interrupt in order to make a true Preemptive kernel.

Round Robin Scheduler

When the scheduler finds tasks on the ready queue that have the same priorities, the scheduler often uses a technique called Round Robin scheduling to make sure each task gets its day in the sun. This means more housekeeping to get it right. This is part of the creative ways you can tailor the scheduler to fit your needs. In the PIC16C54 example, all tasks will get to run shortly after their appointed time. This means that no task will dominate all others in this simple approach. In the “olden” days of the first Real-Time Operating Systems the term was used to mean the same as “time slicing”. The Preemptive Kernels of today are a major step forward, with their priority schemes, and intertask communication capabilities.

Preemptive vs. Non-Preemptive

The Preemptive Kernel is harder to develop, but is easier to use, and is sometimes used incorrectly. You must spend more upfront time with the Non-Preemptive Kernel but it is better for more cramped microcontrollers. You get much better response time between a cause/event and the response/action for that event with a Non-Preemptive Kernel. The Preemptive Kernel is more predictable in the response times, and can be calculated as to the maximum time to complete a given job. Often the Preemptive Kernel is more expensive.

Reentrancy

In a Preemptive Kernel, two or more tasks may want to use the same subroutine. The problem is that you can not control when a task is swapped out and when another takes its place. Thus, if a subroutine uses only local or passed variables that are stored only in each tasks’ stack, then it is call reentrant or a pure routine. No global variables or hardware may be used in such a pure routine. A way around this reentrancy requirement is to treat the whole subroutine as a critical section.

Appendix D is an example of reentrant code segment as might have been used in the PIC16C54 code example.

Task Priority

Some tasks are not created equal. Some jobs must be done on time or data will be lost. Make the tasks that must get done the highest priority and go down the scale from there. Some kernels make you have a different priority for each task. This is a good idea and requires some thought before coding to make the design work.

Static vs. Dynamic Priorities and Priority Inversions

For most embedded Real-Time Kernels, both static priorities and static tasks are used. Dynamic priorities are sometimes used to solve deadlock and other complex situations that arise from not understanding the problem and not understanding Real-Time Techniques. If the need for dynamic priorities seem to occur, you should relook at how you divided the problem, and divide less so as to include the resources in question under one semaphore. You could divide the problem more to have more tasks not needing two or more resources to complete its job, and have the new tasks talk more together.

As for Dynamic tasks, you should define the problem so as to know, ahead of coding, the continuous use of all tasks. You will need more upfront time in the planning stage to get all tasks talking, but it is well worth it to keep Dynamic Priorities and Dynamic Tasking out of the kernel design.

Priority Inversions is a trick used to get past a poorly designed system by inverting the priorities to allow lower tasks to run that were previously blocked. This is a cheap trick, and is best kept out of a Real-Time Kernel. Use the other techniques outlined in this section to solve this kind of problem.

Semaphores

There are basically two types: binary and counting semaphores. The binary semaphore allows only one owner, and all other tasks wanting access are made to wait. The counting semaphore keeps a list of users that need access. Semaphores can be used in many ways. We will illustrate most of them in the following paragraphs. Note that you can implement counting semaphores using binary semaphores.

Mutual Exclusion

We have touched on the subject of Mutual Exclusion earlier (a method to exclude other tasks from gaining access to critical sections). Mutual Exclusion is the process of excluding others from access to the shared resources. To make a semaphore is a very complicated process. The semaphore's construction must be atomic. That means that once the process has started, it can not be interrupted until it has saved the name of the new owner. From there on, it knows that no one else can break-in and change owners. We have implemented a binary semaphore using bits and kernel functions to mutually exclude access in the PIC16C54 example.

In the PIC16C64 example, we also disable interrupts to get the same effect. There are at least two good ways of implementing a binary semaphore. The first and oldest way was discovered by a Dutch mathematician named Dekker. We will refer you to a book that talks more about this algorithm. The second method of implementing a binary semaphore was also discovered by another Dutchman named Dijkstra. This method uses the "testandset" type instruction and is much more important to us. We used the `dec & jump if not zero` instruction (see PIC16C64 example).

Deadlock

Deadlock is a condition where two or more tasks own resources that other tasks need to complete their assignment but will not release their own resources until the other tasks release theirs. Talk about cooperation. Please read section, "Static vs. Dynamic Priorities and Priority Inversions" for a discussion about such problems and ways to solve them. The root of such problems is not understanding the original problem.

Synchronization

Semaphores can be used to synchronize tasks so that messages can be passed between them. Also tasks can be started up by semaphores, stopped by semaphores, or started together. They are the foundation blocks for Real-Time Programming. Once you have built a binary semaphore for your kernel, you can build very complex semaphores to synchronize anything. In the PIC16C54 example, data from several sources are passed out the Serial Port Resource. Task #4 synchronizes the other tasks trying to send data out and synchronizes with task #1 to get it done. When task #1 is running, then task #4 can not run until task #1 is ready for more data to send out.

Intertask Communication

We have touched on this topic already, but for large kernels, one can include more complex communication methods to pass data/messages between tasks. Much of the handshaking is done for you inside the kernel. This takes a lot more space and execution speed to implement them in a kernel.

Event Flags

We implemented Event Flags as simple bits having two states (on and off). More info can be stored per Event Flag such as time it was recorded, by who, and who the event belongs to, and whether data was lost.

Message Mailboxes

This is a nice feature to have if you have the ram space. Mailboxes allow the designer to pass messages between tasks, and allows messages to be looked at when the task is ready, and to reply telling the sender that the message was received. One message can be sent to many tasks at the same time.

Message Queues

This again is a very nice feature if you have the execution time, and the ram to implement them. This feature is related to Mailboxes, in that you can store several messages even after reading, to be processed later. If you want to only operate on the highest prioritized messages before handling the rest, this is allowed. You can be very fancy with the Mailboxes and Queues. If you have them, use them.

Interrupts

Interrupts are one of the best inventions to come along for solving Real-Time problems. You can get very quick response to the need, and then go back to what you were doing. The only problem is that they can and do happen at the worst times. That means that you must learn how to turn them on and off to protect your critical sections. Note that before an interrupt can be handled, you must save all important registers so that you can restore them so that the kernel can restart the task where it left off. This is much like the context switch issue, but for interrupts, you must always save and restore. In the PIC16C64 example, the Status, W, and FSR registers are saved in RAM because of the interrupt. The PC register is saved onto the stack by hardware.

Interrupt Latency, Response and Recovery

Interrupt Latency is defined as the largest time period that interrupts are disabled, plus the time it takes for the ISR to start to execute.

The Interrupt Response Time is defined for a Non-Preemptive system as Interrupt Latency plus the "context saving time." For a Preemptive system, add the execution time for the kernel to record the interrupt.

Interrupt Recovery Time for a Non-Preemptive system is defined as the time to restore the saved context and for the restarting of the task that was interrupted. Interrupt Recovery Time for a Preemptive system is the same as for the Non-Preemptive system plus the time the kernel takes in the scheduler deciding which task to run next. These measurements are how most kernels are compared with each other. The PIC16C64 example does very well in these measurements. That is because of the PIC16CXXX processor and that they are mostly a Non-Preemptive system. You must keep the time you disable interrupts to a minimum in any kernel you write or any task that you write. You should break-up long sequences of instructions to allow for interrupts that are already waiting to execute.

ISR Processing Time

ISR (Interrupt Service Routine) Processing Time is defined as the time an ISR keeps control of the CPU. This amount of time should be short, and if a lot of processing needs to be done in a ISR, then break up the ISR. The new ISR should now just store the new data and return. Next, create a new task and move the extra code from the old ISR into the new task. Remember that the longer you are in one interrupt, the longer you can not answer another pressing interrupt.

Nesting interrupts are where the interrupt with a higher priority can interrupt a lower priority interrupt. Care must be used, as different interrupts may have critical sections too, and disabling interrupts must be used here too to protect critical sections. Nesting of interrupts may not exist on all microcontrollers, such as the PIC16CXXX family.

Non-Maskable Interrupts

On some microprocessors, you can enable/disable selected interrupts, such as on the PICmicro family. This is a great tool to control the flow of data into the system and out. Some systems have what is called Non-Maskable Interrupts. Here you can not turn them off by software masking. These NMIs as they are called for short, are used as clock Ticks, because you do not want problems with complex critical sections on a interrupt that you can not turn off. The PIC16CXXX family does not have any NMIs. NMIs are not as useful as maskable interrupts.

Clock Tick

The Clock Tick, is the heart beat of the system. This is how the kernel keeps time (relative & absolute). This is how the kernel is restarted to see if there is a delay that has finished, so that the task can be moved into the ready state. In the PIC16C54 example, the Timer0 clock is used. In the PIC16C64 example, Timer0 is used. You must have a clock interrupt in order to make a true Preemptive kernel. This is the other reason why we implemented a Non-Preemptive Kernel on the PIC16C54 - no clock interrupt.

ANALYSIS OF CODE EXAMPLES

These sections are the real meat of this article. In these sections we will explain how the concepts are put to practical use line by line in each of the two main examples - PIC16C54 (Appendix C) and PIC16C64 (Appendix D).

We will also examine a short reentrant code example in Appendix B. We will give some ideas on how to expand the examples and how far and how fast the examples can be pushed. Be sure to read both sections on the two examples.

The “Remote Alarm” application has many interesting features. The concept is to have as many tiers of units like a tree feeding into the lower level units the status of each of the larger branches to one central point. Each unit can detect any changes in status before the intruder shuts that unit down, or tampers with it. If any unit’s power or wires connecting it down the tree are cut, the lack of the flow of status and passwords would be noticed in five seconds and reported down the line. The two Serial Input lines per unit receive the status and passwords from its two larger branches, checking the data and passing the info down the line by its own Serial Output line. The seven input status lines are debounced in these examples, showing the technique.

The LED on each unit reports the status at that node as to the importance of its own seven input status lines and the status flowing down the line. The level indication outputted on the LED continues at the last highest level until either a reset is received on the “Reset State” line or five minutes of no new activity on the seven input status lines are received. When either of these two events occur, the level of the LED output is adjusted to the current level of input. Some of the features are changed for this article (Figure 2 and Figure 5).

Another Embedded System use of this type of “Remote Alarm” application is that of placing the unit on the outside of a safe. Hopefully the intruder would be detected before arriving at the unit itself. The continuous stream of status and passwords to the larger unit inside would slow down any simple theft.

PIC16C54 - “Remote Alarm” Example

This example is a cross between a true application and an attempt to show new concepts and some extra features for show. Some of the application specific code has been removed to show more clearly the possibilities of a Real-time Operating System on the PICmicro family. We chose the Baud rate for the Serial output to be twice the speed of the two Serial inputs because it is harder to accurately output a precise Serial Output than it is to monitor Serial inputs.

FIGURE 2: REMOTE ALARM-PIC16C54 EXAMPLE

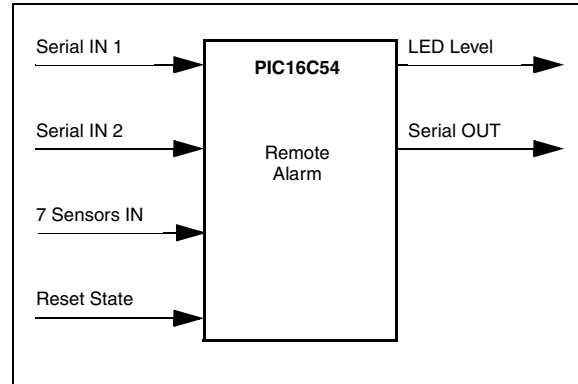

This example operates at 4 Mhz. By simply increasing the crystal speed to 8 MHz, the two Asynchronous input Serial Baud rates increase from 4800 Baud to 9600 Baud. The Serial Output Baud rate increases from 9600 Baud to 19,200 Baud. By increasing the crystal speed to 16 MHz, it will increase the Baud rates to 19,200 Baud for the two independent Asynchronous inputs, and increase the baud rate for the Asynchronous Serial output to 38,400 Baud. By adjusting the constants in the code for the Serial routines, other Baud rates can be achieved at other crystal speeds. Note that you must use a very stable crystal setup and NOT an RC combination to run these examples.

We will now give a quick outline of the PIC16C54 code example. Lines 1-85 are the equates for this program. Lines 88-95 are simple jump tables so as to save some of the precious “first 256 bytes” of each page. The Serial Output Routines - Task #1 are in lines 97-159. Task #7’s subroutines start at line 160 and continue to line 277. In this section, the LED output is controlled. The subroutine QCheck_T123, lines 278-301, is used to allow the checking of Tasks #1-3 to see if they are ready to execute before a long section of code in a slower Task is about to be executed. This is a creative way for the Kernel’s Scheduler to make sure that the highest Prioritized Tasks get serviced before the less important tasks get executed. Task #2 starts at line 302. This task reads the Serial Input #1 for Asynchronous data. Task #2 can be described as a State Machine for outputting a byte Serially. Task #3 interrupts the code of Task #2 at line 333 and continues until line 362. Task #3 also reads the Serial Input but on input #2. Task #2’s subroutines continue at line 363 and continue until line 423. Task #3’s subroutines continue at line 424 and continue until line 484 is reached. The main or starting code is started at line 485. From that line to line 515, all variables are initialized, and all tasks are initialized at this time also. The Main Loop is started at line 516 and ends at line 665. This is where the real action is done. Each task checks the time to see if the conditions are correct for it to run. The tasks that are not Blocked, and have a job to do now are in a Ready State. In the Main Loop, we check the current state of

each task in order of Priority (1-9). If ready, we do a very simple Task Switch and place that task in the Executing State/Running State. Several time unit changes take place in the Main Loop. Tasks #1-4 use 2 μ s as a time base by reading the TMR0 directly. A time unit change takes place at lines 562-575 to 512 μ s per unit for Tasks #5-6. Another time unit change takes place for Tasks #7-9, to 131072 μ s per unit. For Tasks #5-9, each task counts the time units and compares them to their standard for activation or activity. Task #4 starts at line 538 and finishes at line 561. Task #4 controls the feeding of Task #1 from several other tasks that want data to be outputted. It uses several Semaphores to make sure that Task #1 is not bothered until it is ready for another byte. Task #5 monitors the Level Reset Line, and is always running. It simply resets the status of the LED, to be recalculated in Task #6. Task #5 runs through lines 576-581, and is very short. Lines 582-611 represent Task #6. Here we debounce the seven sensor input lines, leaving the current standard in the variable "Old_RB". Task #6 asks/Signals Task #4 to output the current standard out the Serial pin. Task #7's main code is lines 621-628. Task #8 is a five second lack of activity timer, and exists in lines 629-645. If no data comes from either of the two input Serial lines, then Task #8 Signals Task #4 to send a special byte to be outputted by Task #1. This Signals the next "Remote Alarm" of the lack of communication between units. The last task is Task #9. This is a five minute lack of Severe Errors the from Sensor Reset Timer. Lines 646-663 compose Task #9. Subroutine `Do_D_H_E_L` starts at line 667 and continues through to line 692. This routine determines the Highest Error Level, and passes Task #7, the current state, to output on the LED. Lines 693-703, clear the registers #7-1Fh. The "jump at Power-On" code is the last lines 705-706.

The following sections describe in more detail how and what each part of the code does and why. The code segment lines 1-87 are explained in this paragraph. Line 4 tells the MPASM assembler which PICmicro you are using. The include file `PICREG.H` follows with the equates and assignments to make the code more readable and changeable. You should use equates that relate symbols to each other. The Constants — lines 10-12 are the values to change for different Baud rates. They represent the Bit Times for the Baud rates divided by 2 minus some latency factor. You might have to adjust the "Fudge Factor" and other values to fine tune the performance. The value used for the "Fudge Factor" is related to the longest path of code. Lines 21-24 are an experiment that allows a simple name to be associated to a single bit. This allows for easily changeable assignments. Lines 30-54 are the variable assignments. Variables (lines 35-39) are used as time counters. They count the number of units of time, and are compared to literals to see if an Event has just happened. The bits defined in lines 57-64 are used as Binary Semaphores. They keep Critical Sections of data protected. We will see them in action later in the code. The bits defined in lines 67-73 are error flags.

They define the current or last error states of the Serial routines, and whether data was lost coming in or out. The section of equates in lines 76-85 are used to define the different LED activity. They are used by Task #7 to keep the LED blinking. In lines 89-94, we try to save the all important first 256 bytes of any page.

Task #1 outputs a byte Asynchronously over the Serial Output pin. Task #1 is started at line 98. The time units used for Tasks #1-4 are 2 μ S. We first sample the TMR0 and store the count. When Tasks #1-4 are then allowed to run, they check the difference between the first sample and the current time. If the delta is greater than or equal to the delay, then that Event has just happened. We first check if the state of the Serial Output is zero. We then jump to `OStateS` to start the outputting of the "Start Bit". Because any Serial Output timings must be rock solid, we use a trick in lines 101-116 that helps greatly. We check if we are within a certain amount of time BEFORE the deadline and then wait for the time to output another bit. This trick allows us to be within a certain \pm amount of time within the expected time to output that bit. With this code, we are about $\leq 8\%$ accurate for the Serial Output. You can only use this trick on the most critical tasks, and only on one. In this section of code, we are constantly checking the delta of time from the "FIRST_TMR0_O" reading and the current reading of TMR0. When we are very close to the output time, we jump to line 117. If we are not even close to the proper time, we exit back to the main loop, so we can check the other timers and tasks. Now look at Figure 4 for a description of the Output Pulses, the "Bit units of Time", and the associated state numbers. Note that the activities are spread out over time.

The timer Events help to define the different states and their associated output activities. Each Event is handled in a very short, well-defined set of code as Task #1. Lines 117-131, are a quick state jump table. You need to break all Real-Time code into very short segments — in and then out. Each segment is just a few lines long. You do your activity, save status, and increment to the next state. Notice that `OState0_7` code is used several times to output all 8 bits. The state variable is used also to count the number of bits already outputted. The time to the next outputting of a bit is calculated and is adjusted to take out the accumulation of errors in lines 151-152. We make sure of a full "Stop Bit" length in the `OStateE` code. In the `OStateL` code, we reset the `OState` variable to zero, and tell the world that we are not outputting now in line 157. This is important because we use that bit (`OState_B`) to Signal that we need to protect the variable `xmt_byte` that changes over several states. We also use it to Signal that we are ready for another byte to output. Look at Task #4. See how it uses this Semaphore to full advantage. We have just explained a Critical Segment variable as outlined in the theory sections of this article.

Task #2 reads the Serial Input line 1, running at 4800 Baud. The code structure is very similar to that of Task #1 (Figure 3). Notice that there are more states than the Serial Output Task #1. Once the “Start Bit” is detected, we half step into the “Start Bit” to see if it was a “False Start” or not. We then sample and store the incoming bits to form an 8-bit byte just like Task #1. We sample the “Stop Bit” to see if it is a “Frame Error”. We delay another 1/2 bit to get to the end of the “Stop Bit” if there was an “Frame Error” before resetting Task #1’s state to 0. Otherwise, we reset Task #1’s state to 0, and Signal that we are ready for another “Start Bit”. The just received byte is stored in variable “RCV_Storage”. A check is made to see if we already sent out the last received byte before clobbering the old byte with the new byte.

Task #3 reads the Serial Input line 2, running at 4800 Baud. The code structure is the same as Task #2 (Figure 3). The received byte is also put into the same storage variable as Task #2 - “RCV_Storage”. When either Task #2 or Task #3 receives a valid byte, Task #8’s counter is reset. You can up the Baud rate of Task #2 and 3 if you lower the output Baud rate of Task #1. Note that for reading the Serial Input Lines, you can be off by ±15% for each sampling, but not accumulatively.

Task #4 finds the next buffered byte to send out through Task #1. Task #4 also controls the order of which byte goes first over another less important byte of data. It can be said that Task #1 Blocks Task #4 from running. You can think of the Serial Output Line as a Shared Resource. The use of Semaphores here allow the Synchronization of data and actions.

Task #5 monitors the Level Reset Input Line and will reset the LED state variable if the line ever goes low. This task is always in the Ready State. This task is said to simply “pole the input line” when ever it can.

Task #6 debounces the seven sensor input lines, running every 20 ms. The variable “T_20_mS_CO” is incremented every 512 μs (Clock Tick) and is compared to the count needed to equal 20 ms. If it is time, the subroutine QCheck_T123 is called to see if Tasks #1-3 are in the Ready State. If any of the Tasks #1-3 are ready, they are ran and we then continue with Task #6. We compare the current value of the input Port_B to see if it stayed the same from the last reading 20 ms back. If the two readings are the same, then Port_B is considered to be stable and the possibly new value is placed in the variable “Old_RB” to be outputted by Task #1. The subroutine D_H_E_L is called to determine the new LED state. We then check if Task #1 was too busy to output the last sensor status byte, if so then that error is recorded.

FIGURE 3: SERIAL INPUT STATES vs. TIME DIAGRAM

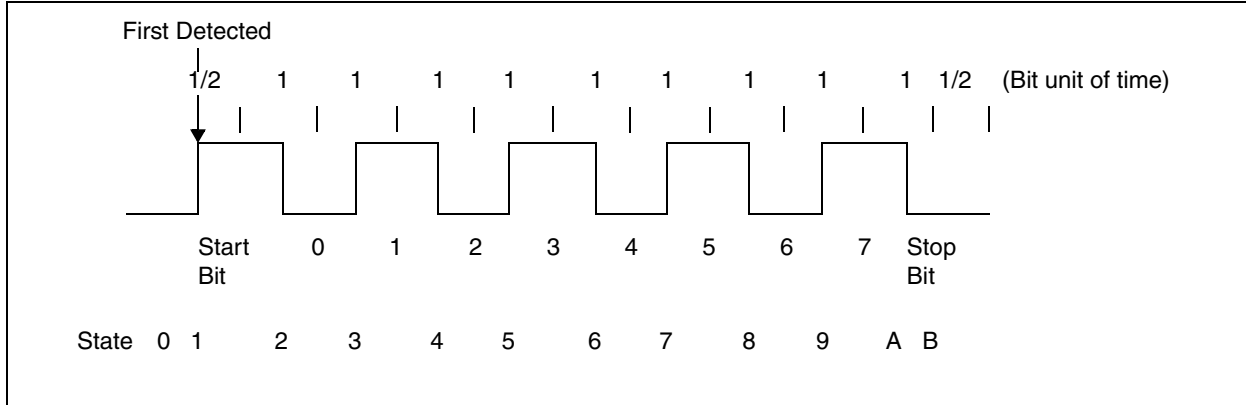
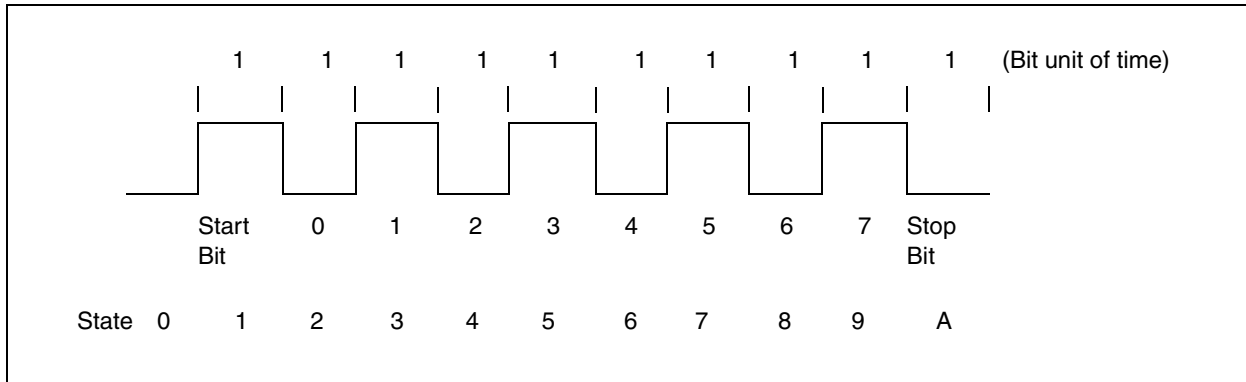

FIGURE 4: SERIAL OUTPUT STATES vs. TIME DIAGRAM



Task #7 outputs the Highest Severity Level Indication on the LED. Do_LED starts at line 161, and continues to 276. This task is also broken into small time units of code. It is constantly checking to see if it is time to switch the on/off condition of the LED. The time units for Task #7 are regulated by the code in lines 613-619. $131072 \mu\text{S}$ = time unit for Tasks #7-9. Task #7 has many state jump tables so it is included in the first 256 bytes of the first page. Lines 168-175 explain the on and off sequences and offs that represent levels of severity of the input status lines. The variable "LED_Mode" has both Task #7's current state number and the sub-state-number for that state's output sequence.

Task #8 is a 5 second lack of input from either of the two Serial input timers. Tasks #2 and #3 will reset the time counter for Task #8, when either receives a full byte. If the time counter "T_5_S_CO" equals 5 secs, then the LED's state is bumped to the highest, and a special byte is sent down the line to the next "Remote Alarm" unit. The counter variable is reset, and count starts all over. We then check if Task #1 was too busy to output the last special status byte, if so then that error is recorded.

Task #9 measures 5 minutes of calm on the 7 sensor lines and then resets the LED's state. Task #9 needs 16 bits of counter power to record 5 minutes of time. The counter variables are reset after being triggered.

Do_D_H_E_L determines the LED's next state based on the 7 sensor input status. This subroutine checks each bit to see if it is active and then checks if a change in the LED's current state needs changing.

Do_Clear_Regs clears registers 7-1Fh. It leaves the FSR register zeroed out. This is very important for the PIC16C57 chip.

PIC16C64 - "Remote Alarm64" Example

This example is the same as the PIC16C54 example with a few changes to take advantage of the three timers on the PIC16C64 and interrupts. The second Serial input routine was replaced by an example of a software PWM (Pulse Width Modulation) example. The same code as the PIC16C54 example will run on the PIC16C64 with very few changes using only the TMR0 (TMR0). Be sure to read about the PIC16C54 example, as the comments will not be repeated, except to make a strong point.

FIGURE 5: REMOTE ALARM - PIC16C64 EXAMPLE

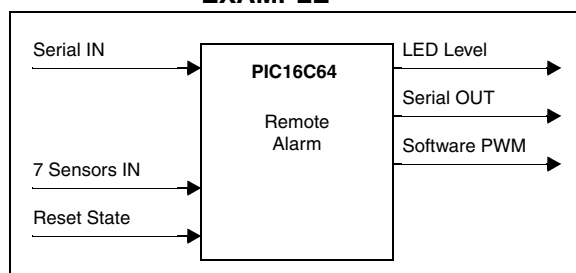

This example operates at 4 Mhz. By simply increasing the crystal speeds, you can change the input and output Baud rates just as outlined in the section on the PIC16C54 example's crystal selection. By adjusting the constants in the code for the Serial routines, other Baud rates can be achieved at other crystal speeds.

Note: You must use a very stable crystal setup and NOT an RC combination to run these examples.

We will now give a quick outline of the PIC16C64 code example. Lines 1-78 are the equates for this program. Notice that there is no need for jump tables for subroutines to be in the "first 256 bytes" of each page as there was in the PIC16C54 example. Note that the "Reset Vector" is now at code address 0, and the "Interrupt Vector" is at code address 4. Task #1 and 2 have been simplified greatly by using interrupts and timers. For Task #1, we no longer need to use the "trick" any more. It is time to execute once the routines for Task #1 and others are called. The section of code that handles the "Start Bit" (OStateS) lines 106-122 has been changed to setting up TMR2 with its interrupt to trigger the next call to this subroutine. The initial CALL to this subroutine was by Task #4, but later calls are due to Timer 2's interrupts. The amount of time until the next interrupt is set by each state's code. This amount is based on the "Bit Unit of Time" which is based on Baud rate and crystal speed. An easy change to the code is to add a software selectable and "changeable on the fly" Baud rate. This is done by having a variable that selects the new Baud rate from the two data tables. One table gets you the Bit Delay value - see line 110. The other data table gets the value to be put into T2CON - see line 107, which selects the Post and Pre-scalers. You may need to adjust the Bit Delay value to take in account the Interrupt Latency. The OStateL state code shuts down Timer2 and its interrupt. See lines 647-676 to understand how we get here by interrupt. Once Timer 2's count equals the count we put into register PR2, we get an interrupt if the following three conditions are true:

1. Not already in an interrupt. When the current interrupt is done, our interrupt will be executed.
2. GIE and PEIE bits are set.
3. TMR2IE bit is set.

Remember to clear the Flag bit as in line 114 before returning from an interrupt. Return from this subroutine will return you back to Task #4 or back to the ISR handle lines 647-676 depending on who called this routine. The Task #7's subroutines are the same as in the PIC16C54 example, lines 151-268. Task #2 is different from the previous example, lines 288-380. First Task #2 uses two interrupts. The INT interrupt on pin RB0/INT is used to detect the "Start Bit". It is very accurate. It is turned off after the detection in I1StateS code. The second interrupt TMR1 is then Enabled in the I1StateS code. Timer1 is then used to cause an interrupt for all the other states for Task #2. Notice that

Timer1 has a 16-bit counter and we calculate the amount of Clock Ticks until overflow in lines 329-333. In the state code I1StateL, TMR1 is shut down, and the INT interrupt is now Enabled so as to detect the next input byte. The initializing of the PIC16C64 variable takes place in lines 383-426. The initializing of the tasks take place in lines 427-451. Notice that the last bit to be set is the GIE bit in line 451 after ALL is setup. There are several ways to execute the Task #3-9 code: by Timer0 overflow interrupt, by having the code be in the background as in this example. The trade-offs are many, and too deep for this article. Notice that the subroutine QCheck_T123 is not needed in this method. Timer0 overflow interrupt sets the flag: Time_Bit. The code in lines 454-457 can be considered the "IDLE Task" on some systems. It waits for a Clock Tick from TMR0's overflow. Task #3 is new, and is a simple 8-bit software PWM. Lines 459-478 show how to have 8 bits of ON, and 8 bits of OFF. This task has two states, on and off. You may add to the code by allowing the Real-Time changing of the 8-bit values under software control. When you change the values in the variables PWM_Out and PWM_In, disable all interrupts by using the following line: `BCF INTCON,GIE`, and enable all interrupts by using the following line: `BSF INTCON,GIE`. The new values will be used at the next transition, thus allowing a smooth change. This task could easily be used in the PIC16C54 example type Kernel. Task #4 is the same except that it calls Task #1's subroutine to initiate the outputting of a byte. See line 503. Tasks #5-9 are the same as in the PIC16C54 example. The subroutines: `D_H_E_L` and `Clear_Regs` are the same in both examples. The TMR0 (Timer0) Overflow interrupt ISR (Interrupt Service Routine) is lines 641-645. This ISR will set the Time_Bit bit and clear the Flag that caused the interrupt. The Interrupt code lines 647-676 handles the saving of the Context Registers and the restoring of the Context Registers (W, Status, FSR) and by checking the order which interrupts are to be handled first - see lines 656-669. A very important line is 654. You must set the memory page pointers here for the ISR routines! Line 676 is the only place that an interrupt is allowed to return and set the GIE bit (`RETFIE`).

Reentrant example

See Appendix B for the short code segment. This code corresponds to lines 302-332 in the PIC16C54 example. The purpose of reentrant code is to allow two or more tasks to use the same code at the "same time". See the section about reentrant in the theory section of this article. Notice how the registers 18h-1Bh match the registers 1Ch-1Fh, both starting with the state variable for the two tasks using this routine. Note how Task #2 and Task #3 load a pointer to the state variable for their task before calling DO_I State code. By using the FSR register as a pointer, and incrementing or decrementing the FSR register, you can keep the variables in the two tasks straight even if the two tasks are using different code in the subroutine at any one time. This method is not easy to implement, as can be seen, so use two copies for readability instead, like the PIC16C54 example.

SUMMARY

Now that the PICmicro family of microcontrollers have a way of executing Real-Time Programs, using the techniques outlined in this article, there is very little that PICmicros cannot do! Much more than was ever dreamed before. Many of you will quickly understand and start modifying these examples. Great. That means that we have done our job at Myriad. A few of you may want more help. Great. At Myriad Development Co., we LOVE the PICmicro family.

BIBLIOGRAPHY

Foster, Caxton C.

Real Time Programming - Neglected Topics

Reading, Massachusetts

Addison-Wesley Publishing Company, 1981

Holt, R.C., Graham, G.S., Lazowska, E.D., Scott, M.A.

Structured CONCURRENT PROGRAMMING with Operating Systems Applications

Reading, Massachusetts

Addison-Wesley Publishing Company, 1978

Kaisler, Stephen H.

The Design of Operating Systems for Small Computer Systems

New York, NY

John Wiley & Sons, 1983

Labrosse, Jean J.

uC/OS - The Real-Time Kernel

Lawrence, Kansas

R & D Publications, 1992

Loeliger, R.G.

Threaded Interpretive Languages

Peterborough, NH

BYTE BOOKS, 1981

APPENDIX A:

A Real-Time Vocabulary

ASYNCHRONOUS - An activity that can happen at any moment, at any time.

BLOCKING - The act of wanting to waiting for an EVENT before continuing.

CLOCK TICK - The heart beat that all time is based on.

CONTEXT/TASK SWITCH - Module that saves and restores the states of a task.

CRITICAL SECTION - Section of code or hardware - only one user at a time.

DEADLOCK - That is where two TASKs are waiting for each others resources.

DISPATCHING - The act of starting up a TASK to run from an RT Kernel.

DYNAMIC PRIORITIES - The ability for TASKs to have there PRIORITIES changed.

DYNAMIC TASKING - The creation and the killing of TASKs.

EMBEDDED SYSTEM - An internal system that operates all by itself.

ENABLING/DISABLING INTERRUPTS - Controlling the interrupting processing.

EVENT - Timer, communication, handshaking, interrupts, data, external events.

EVENT FLAGS - The storage of current states or info on what has happened.

INTERRUPT - A hardware event (external/internal) that triggers a jump to the ISR routines to handle that event.

INTERRUPT LATENCY - How long it takes once signaled to start an ISR.

INTERRUPT RECOVERY - How long it takes once interrupted to return back to code.

KERNEL - Module that controls TASKs, INTERRUPTS, and intertask communications.

MAILBOXES - Away to pass data from one TASK to another.

MASKABLE INTERRUPTS - The ability to control whether an ISR is called or not.

MULTITASKING - The act of several TASKs thinking they own the CPU.

MUTUAL EXCLUSION - The act of allowing only ONE owner to a RESOURCE.

NMI - NON-MASKABLE INTERRUPT - Can not be turned off by software.

READY STATE - Referring to a list of TASKs ready (having work to do NOW).

REENTRANT - Code that can be used by several TASKs at the same time.

RESOURCE - Data structures, display, I/O hardware, non-reentrant routines.

RUNNING STATE - Referring to the ONE task owning/using the CPU currently .

SCHEDULER - That part of a kernel that decides which TASK to run next.

SEMAPHORES - A protocol to control RESOURCES, SIGNAL EVENTS, synchronize tasks.

SIGNAL - The act of one task signaling another that something has happened.

STATE MACHINE - An important concept in dividing a job into TASKs & ISRs.

SYNCHRONIZATION - Were TASKs synchronize over data or at a special time.

TASK PRIORITY - Each TASK is ranked as to its importance to getting done.

TASK/THREAD - Code that is defined by a small coherent job/work to be done.

TIME SLICING - The act of giving the same amount of "time" to each TASK to run.

TRAP - A software caused interrupt, useful for system access.

WAITING STATE - Referring to a list of TASKs waiting for an EVENT(s).

Please check the Microchip BBS for the latest version of the source code.

Microchip's Worldwide Web Address: www.microchip.com; Bulletin Board Support: MCHIPBBS using CompuServe®
(CompuServe membership not required).

APPENDIX B:

MPASM 01.40 Released

APP_B.ASM 1-16-1997 17:09:04

PAGE 1

```

LOC OBJECT CODE      LINE SOURCE TEXT
VALUE

                                00001          list    p=16C54,t=ON,c=132
                                00002          ;
                                00003          ;*****
                                00004          ;
                                00005          ; 'Reentrant Code Example' Designed by Myriad Development Co. - Jerry
Farmer
                                00006          ;          PIC16C54, 4MHz Crystal, WatchDog Timer OFF
                                00007          ;
                                00008          ;          Program:          APP_B.ASM
                                00009          ;          Revision Date:
                                00010          ;                      1-15-97    Compatibility with MPASMWIN 1.40
                                00011          ;
                                00012          ;*****
                                00013          ;
                                00014          ; Register Files
00000018          00015 IState1      equ     18h    ;Serial In #1 State
00000019          00016 First_TMR0_I1 equ     19h    ;Starting time for next #1 Input event
0000001A          00017 nbt1      equ     1Ah    ;Next Bit #1 In Time - variable time
0000001B          00018 rcv_byte_1 equ     1Bh    ;Receive Serial #1 In byte
0000001C          00019 IState2      equ     1Ch    ;Serial In #2 State
0000001D          00020 First_TMR0_I2 equ     1Dh    ;Starting time for next #2 Input event
0000001E          00021 nbt2      equ     1Eh    ;Next Bit #2 In Time - variable time
0000001F          00022 rcv_byte_2 equ     1Fh    ;Receive Serial #2 In byte
                                00023
                                00024          INCLUDE  <P16C5X.INC>
                                00001          LIST
                                00002          ;P16C5X.INC Standard Header File,Version 3.30 Microchip Technology,Inc.
                                00224          LIST
                                00025
00000007          00026 temp        EQU     07h    ;Temporary holding register - PIC16C54/56
00000010          00027 IStateS      EQU     10H
00000011          00028 IStateS2     EQU     11H
00000012          00029 IState0_7   EQU     12H
00000013          00030 IStateE      EQU     13H
00000014          00031 IStateL      EQU     14H
                                00032
                                00033          ;***** ;Task 2,3 - Asynchronous 2400 Baud Serial Input (LOW=0)
0000          00034 Do_IState
0000 0220          00035          movf    INDF, F    ;if IState2 == 0
0001 0643          00036          btfsc  STATUS,Z    ; then Do Start Bit
0002 0A10          00037          goto   IStateS
0003 0201          00038          movf   TMR0,W      ;Get current time
0004 0027          00039          movwf  temp
0005 02A4          00040          incf   FSR, F      ;Point to First_TMR0_I(1,2)
0006 0200          00041          movf   INDF,W      ;Get elapsed time; Time Unit = 2 uS
0007 00A7          00042          subwf  temp, F
0008 02A4          00043          incf   FSR, F      ;Point to nbt1(1,2)
0009 0200          00044          movf   INDF,W      ;Past time for next input bit ?
000A 0087          00045          subwf  temp,W
000B 0703          00046          btfss  STATUS,0
000C 0A1E          00047          goto   L1
000D          00048 L0

```

AN585

```
000D 0C02      00049      movlw    2          ;Point to IState(1,2)
000E 00A4      00050      subwf   FSR, F
000F 0200      00051      movf   INDF,W      ;Get (0-B) mode #
0010 0E0F      00052      andlw  H'0F'      ;Get only mode #
0011 01E2      00053      addwf  PCL, F      ;jump to subroutine
                00054
0012 0A10      00055      goto   IStateS     ;Serial Start Bit
0013 0A11      00056      goto   IStateS     ;1/2 of Start Bit - see if False Start
0014 0A12      00057      goto   IState0_7   ;Bit 0
0015 0A12      00058      goto   IState0_7   ;Bit 1
0016 0A12      00059      goto   IState0_7   ;Bit 2
0017 0A12      00060      goto   IState0_7   ;Bit 3
0018 0A12      00061      goto   IState0_7   ;Bit 4
0019 0A12      00062      goto   IState0_7   ;Bit 5
001A 0A12      00063      goto   IState0_7   ;Bit 6
001B 0A12      00064      goto   IState0_7   ;Bit 7
001C 0A13      00065      goto   IStateE     ;Serial Stop Bit
001D 0A14      00066      goto   IStateL     ;Last State
001E          00067 L1
001E 0064      00068      clrf   FSR        ;Clear the FSR register
001F 0800      00069      retlw  0
                00070
                00071 ;*****
0020          00072 Task_2      ;Task 2 - Asynchronous 2400 Baud Serial Input (LOW=0)
0020 0C18      00073      movlw  IState1     ;Point to IState1
0021 0024      00074      movwf  FSR
0022 0900      00075      call  Do_IState
                00076 ;*****
0023          00077 Task_3      ;Task 3 - Asynchronous 2400 Baud Serial Input (LOW=0)
0023 0C1C      00078      movlw  IState2     ;Point to IState2
0024 0024      00079      movwf  FSR
0025 0900      00080      call  Do_IState
                00081
                00082      END
```

MEMORY USAGE MAP ('X' = Used, '-' = Unused)

0000 : XXXXXXXXXXXXXXXXXXXX XXXXXXXXXXXXXXXXXXXX XXXXXX-----

All other memory blocks unused.

Program Memory Words Used: 38
Program Memory Words Free: 474

Errors : 0
Warnings : 0 reported, 0 suppressed
Messages : 0 reported, 0 suppressed

Please check the Microchip BBS for the latest version of the source code. Microchip's Worldwide Web Address: www.microchip.com; Bulletin Board Support: MCHIPBBS using CompuServe® (CompuServe membership not required).

APPENDIX C:

MPASM 01.40 Released

APP_C.ASM 1-16-1997 17:09:32

PAGE 1

```

LOC OBJECT CODE      LINE SOURCE TEXT
VALUE

00001 ;`Remote Alarm' V1.02
00002 ;  Designed by Myriad Development Co/- Jerry Farmer
00003 ;    PIC16C54, 4MHz Crystal,
00004 ;      WatchDog Timer OFF, MPASM instruction set
00005 ;
00006 ;      Program:          APP_C.ASM
00007 ;      Revision Date:
00008 ;                          1-15-97  Compatibility with MPASMWIN 1.40
00009 ;
00010 ;*****
00011 ;
00012      list      p=16C54,t=ON,c=132
00013
00014      include "P16C5X.INC"
00001      LIST
00002 ;P16C5X.INC Standard Header File, Ver. 3.30 Microchip Technology, Inc.
00224      LIST
00015
00016 ; Constants
00000000 00017 INDIR      equ 0          ;Indirect Register
00000033 00018 OUT_BIT_TIME equ 33h         ;9600 Baud, 104uS Bit Rate
00000064 00019 IN_BIT_TIME  equ 64h         ;4800 Baud, 208uS Bit Rate
00000023 00020 FUDGE_TIME   equ 23h         ;Current Time within a Fudge Factor
00021
00022 ; B Register Definitions
00023 #define Level_Reset      PORTB, ;Low will cause Past Level to reset
00024                                ;RB.7 - RB.1 == Input from Sensors
000000FF 00025 RB_TRIS      equ B'11111111' ;RB TRIS at INIT State == all input
00000000 00026 RB_MASK     equ B'00000000' ;What is High/Low for RB at INIT State
00027
00028 ; A Register Definitions - Programmable Inputs
00029 #define Serial_IN_1      PORTA,0 ;Serial Input #1 - 8 bits
00030 #define LED              PORTA,1 ;LED Output - Level/State Indicator
00031 #define Serial_Out      PORTA,2 ;Serial Output - 8 bits + passwords
00032 #define Serial_IN_2      PORTA,3 ;Serial Input #2 - 8 bits
00033
000000F9 00034 RA_TRIS      equ B'11111001' ;RA TRIS at INIT State
00000000 00035 RA_MASK     equ B'00000000' ;What is High/Low for RA at INIT State
00036
00037 ; Register Files
00000007 00038 temp        equ 07h         ;Temporary holding register - PIC16C54/56
00000008 00039 Timer_Bits  equ 08h         ;Indicates which Timer(s) are Active = 1
00000009 00040 Flags       equ 09h         ;Error Flags
0000000A 00041 LED_Mode   equ 0Ah         ;(0-2)=Mode, 3=LED_B, (4-6)=Seq #, 7=NEW
0000000B 00042 OState    equ 0Bh         ;Serial Out State
0000000C 00043 T_5_M_LO   equ 0Ch         ;5 Min Timer Counter - Low
0000000D 00044 T_5_M_HI   equ 0Dh         ;5 Min Timer Counter - High
0000000E 00045 T_5_S_CO   equ 0Eh         ;5 Second Timer - lack of Serial Input
0000000F 00046 T_20_mS_CO equ 0Fh         ;20 mS Timer - used for debouncing
00000010 00047 LED_C     equ 10h         ;LED Counter
00000011 00048 Last_TMR0   equ 11h         ;Last value of the TMR0
00000012 00049 First_TMR0_O equ 12h         ;Starting time for next Output event
00000013 00050 xmt_byte   equ 13h         ;Serial xmit byte - destroyed in use
00000014 00051 cc      equ 14h         ;256 * TMR0 time

```

```

00000015      00052 RCV_Storage      equ    15h      ;Long term storage of rcv_byte #1 & 2
00000016      00053 Old_RB          equ    16h      ;Oldest/Master copy of RB
00000017      00054 Last_RB          equ    17h      ;Last copy of RB
00000018      00055 IState1         equ    18h      ;Serial In #1 State
00000019      00056 First_TMR0_I1    equ    19h      ;Starting time for next #1 Input event
0000001A      00057 nbt1l           equ    1Ah      ;Next Bit #1 In Time - variable time
0000001B      00058 rcv_byte_1       equ    1Bh      ;Receive Serial #1 In byte
0000001C      00059 IState2         equ    1Ch      ;Serial In #2 State
0000001D      00060 First_TMR0_I2    equ    1Dh      ;Starting time for next #2 Input event
0000001E      00061 nbt2            equ    1Eh      ;Next Bit #2 In Time - variable time
0000001F      00062 rcv_byte_2       equ    1Fh      ;Receive Serial #2 In byte
00063
00064 ; Indicates which Timer(s) are Active = 1 & Flags
00065 #define OState_B      Timer_Bits,0;Serial Out Active Bit
00066 #define IState1_B     Timer_Bits,1;Serial IN #1 Active Bit
00067 #define IState2_B     Timer_Bits,2;Serial IN #2 Active Bit
00068 #define T_5_S_B       Timer_Bits,3;5 Second Timer Active Bit
00069 #define T_5_M_B       Timer_Bits,4;5 Min Timer Active Bit
00070 #define RCV_Got_One_B Timer_Bits,5;Got a NEW Received byte to send out
00071 #define RB_NEW_B      Timer_Bits,6;Indicates a change in RB input
00072 #define S_5_S_B       Timer_Bits,7;Serial In 5 secs of inactivity
00073
00074 ; Error Flags
00075 #define FS_Flag_1      Flags,0      ;Serial #1 IN had a False Start Error
00076 #define FE_Flag_1      Flags,1      ;Last Serial #1 IN had a Frame Error
00077 #define FS_Flag_2      Flags,2      ;Serial #2 IN had a False Start Error
00078 #define FE_Flag_2      Flags,3      ;Last Serial #2 IN had a Frame Error
00079 #define RCV_Overflow   Flags,4      ;Lost Serial Input Byte - too Slow
00080 #define RB_Overflow    Flags,5      ;Lost RB Input Byte - too Slow
00081 #define S_5_S_Overflow Flags,6      ;Lost '5S Inactivity' msg - too Slow
00082
00083 ;Equates for LED Task #7
00084 #define LED_B           LED_Mode,3    ;LED is active
00085 #define LED_NEW_B      LED_Mode,7    ;LED has just changed Modes = 1
00086 LED_OFF_MODE          equ    B'00001000' ;LED OFF
00087 LED_SEQ1_MODE          equ    B'10001001' ;LED Sequence 1: .2s On, 1s Off
00088 LED_SEQ2_MODE          equ    B'10001010' ;LED Sequence 2: 3x(.2s), 1s Off
00089 LED_SEQ3_MODE          equ    B'10001011' ;LED Sequence 3: 5x(.2s), 1s Off
00090 LED_SLOW_MODE          equ    B'10011100' ;LED Slow Pulsing - .3 Hz
00091 LED_MEDIUM_MODE       equ    B'10011101' ;LED Medium Pulsing - 1 Hz
00092 LED_FAST_MODE         equ    B'10011110' ;LED Fast Pulsing - 3 Hz
00093 LED_ON_MODE           equ    B'10001111' ;LED ON Continuously
00094
00095
00096 ; Clear Registers 7-1Fh
00097 Clear_Regs
0000 0BE9      00098      GOTO      Do_Clear_Regs      ;Save space in first 256 bytes
00099
00100 ; Determine the Highest Error Level & Start Task #7 outputing the new
0001 0BD2      00101 D_H_E_L
00102      GOTO      Do_D_H_E_L      ;Save space in first 256 bytes
00103      ;Level
00104 ;*****      ;Task #1 - Asynchronous 9600 Baud Serial Output (LOW=0)
0002 022B      00105 Do_OState
00106      MOVF      OState, F      ;if OState == 0
0003 0643      00107      BTFSC     STATUS,Z      ;
0004 0A24      00108      GOTO      OStateS      ;then goto Output-Start-Bit
0005 0201      00109      MOVF      TMR0,W      ;Get current time
0006 0207      00110      MOVWF     temp      ; & store in Temporary variable
0007 0212      00111      MOVF      First_TMR0_O,W ;Get elapsed time; Time Unit = 2 us
0008 00A7      00112      SUBWF     temp, F      ;Delta of Current Time & Orginal Time
0009 0C23      00113      MOVLW    FUDGE_TIME ;Take in account processing time to do it
000A 0087      00114      SUBWF     temp,W      ;Time within fudge factor ?
000B 0703      00115      BTFSS     STATUS,C
000C 0A23      00116      GOTO      _0005      ;Not time yet to change States so return
000D 0C33      00117      MOVLW    OUT_BIT_TIME ;Past time for next out-bit ?

```



```

000E 0087      00118      SUBWF    temp,W
000F 0603      00119      BTFSC   STATUS,C      ;Do some delaying until it is time
0010 0A15      00120      GOTO    _0004         ;It is now time to out put a bit
0011 0C04      00121      MOVLW   H'04'        ;Account for loop delay
0012 01E7      00122      ADDWF   temp, F
0013 0000      00123      NOP
0014 0A0D      00124      GOTO    _0003         ; make loop delay even
0015 020B      00125 _0004  MOVF    OState,W     ;Wait for exact time to output bit
0016 0E0F      00126      ANDLW   H'0F'        ;Get (0-A) mode #
0017 01E2      00127      ADDWF   PCL, F       ;Get only mode #
0018 0A24      00128      GOTO    OStateS      ;jump to subroutine
0019 0A2B      00129      GOTO    OState0_7   ;Serial Start Bit
001A 0A2B      00130      GOTO    OState0_7   ;Bit 0
001B 0A2B      00131      GOTO    OState0_7   ;Bit 1
001C 0A2B      00132      GOTO    OState0_7   ;Bit 2
001D 0A2B      00133      GOTO    OState0_7   ;Bit 3
001E 0A2B      00134      GOTO    OState0_7   ;Bit 4
001F 0A2B      00135      GOTO    OState0_7   ;Bit 5
0020 0A2B      00136      GOTO    OState0_7   ;Bit 6
0021 0A31      00137      GOTO    OStateE      ;Bit 7
0022 0A36      00138      GOTO    OStateL      ;Serial Stop Bit
0023 0800      00139 _0005  RETLW   H'00'        ;Last State
0024          00140
0024          00141 OStateS
0024 0545      00142      BSF     Serial_Out   ;Serial Start Bit
0025 0201      00143      MOVF    TMR0,W       ;Store starting time
0026 0032      00144      MOVWF   First_TMR0_O
0027 0C0D      00145      MOVLW   H'0D'        ;Fudge again
0028 00B2      00146      SUBWF   First_TMR0_O, F
0029 02AB      00147      INCF    OState, F   ;increment to next state
002A 0800      00148      RETLW   H'00'
002B          00149
002B          00150 OState0_7          ;Bit 0 - 7
002B 0333      00151      RRF     xmt_byte, F  ;Move bit into C from right most bit
002C 0703      00152      BTFSS   STATUS,C     ;
002D 0445      00153      BCF     Serial_Out   ;
002E 0603      00154      BTFSC   STATUS,C     ;
002F 0545      00155      BSF     Serial_Out   ;
0030 0A32      00156      GOTO    OS_End
0031          00157 OStateE
0031 0445      00158      BCF     Serial_Out   ;Serial Stop Bit
0032 0C33      00159 OS_End  MOVLW   OUT_BIT_TIME ;Adjust out the cumulation of error
0033 01F2      00160      ADDWF   First_TMR0_O, F
0034 02AB      00161      INCF    OState, F   ;increment to next state
0035 0800      00162      RETLW   H'00'
0036          00163 OStateL
0036 006B      00164      CLRF    OState       ;Ready to send next byte out
0037 0408      00165      BCF     OState_B     ;Serial Out not active
0038 0800      00166      RETLW   H'00'
0039          00167
0039          00168 ;*****          ;Task #7 - Output Highest Level Indication on LED
0039          00169 Do_LED
0039 06EA      00170      BTFSC   LED_NEW_B    ;Initialize regs if change in modes
003A 0A4C      00171      GOTO    LED_NEW
003B 02B0      00172      INCF    LED_C, F     ;Inc Counter - Time Unit = 131072 uS
003C 020A      00173      MOVF    LED_Mode,W   ;Get (0-7) mode #
003D 0E07      00174      ANDLW   H'07'        ;Get only mode #
003E 01E2      00175      ADDWF   PCL, F       ;jump to subroutine
003F 0A48      00176      GOTO    LED_OFF      ;LED OFF
0040 0A64      00177      GOTO    LED_SEQ1     ;LED Seq 1: 1 short pulse & pause
0041 0A67      00178      GOTO    LED_SEQ2     ;LED Seq 2: 2 short pulses & pause
0042 0A8A      00179      GOTO    LED_SEQ3     ;LED Seq 3: 3 short pulses & pause
0043 0A50      00180      GOTO    LED_SLOW     ;LED Slow Pulsing - .3 Hz
0044 0A5E      00181      GOTO    LED_MEDIUM   ;LED Medium Pulsing - 1 Hz
0045 0A61      00182      GOTO    LED_FAST     ;LED Fast Pulsing - 3 Hz
0046 0A4D      00183      GOTO    LED_ON       ;LED ON Continuously

```

```

0047 0800          00184 _0012  RETLW  H'00'
                   00185 ;-----
0048              00186 LED_OFF
0048 0425          00187          BCF    LED           ;Turn off LED
0049 046A          00188          BCF    LED_B          ;LED must be off
004A 0070          00189          CLRF   LED_C          ;Reset Counter - LED_C = 0
004B 0800          00190          RETLW  H'00'
                   00191 ;-----
004C              00192 LED_NEW
004C 04EA          00193          BCF    LED_NEW_B        ;Done initializing
004D              00194 LED_ON
004D 0525          00195          BSF    LED           ;Turn on LED
004E 0070          00196          CLRF   LED_C          ;Reset Counter - LED_C = 0
004F 0800          00197          RETLW  H'00'
                   00198 ;-----
0050              00199 LED_SLOW
0050 0C0C          00200          MOVLW  H'0C'          ;.3Hz @ 50% Duty
0051 0027          00201          MOVWF  temp
0052 0207          00202 LED_S    MOVF   temp,W          ;Check LED_C if time, .3Hz @ 50% Duty
0053 0090          00203          SUBWF  LED_C,W
0054 0743          00204          BTFSS  STATUS,Z
0055 0A47          00205          GOTO   _0012
0056 0C10          00206          MOVLW  H'10'
0057 01AA          00207          XORWF  LED_Mode, F    ;Switch states
0058 078A          00208          BTFSS  LED_Mode,4    ;Now make LED same state
0059 0425          00209          BCF    LED
005A 068A          00210          BTFSC  LED_Mode,4
005B 0525          00211          BSF    LED
005C 0070          00212          CLRF   LED_C          ;Reset LED_C
005D 0800          00213          RETLW  H'00'
                   00214 ;-----
005E              00215 LED_MEDIUM
005E 0C04          00216          MOVLW  H'04'          ;1Hz @ 50% Duty
005F 0027          00217          MOVWF  temp
0060 0A52          00218          GOTO   LED_S          ;Go do it
                   00219 ;-----
0061              00220 LED_FAST
0061 0C01          00221          MOVLW  H'01'          ;3Hz @ 50% Duty
0062 0027          00222          MOVWF  temp
0063 0A52          00223          GOTO   LED_S          ;Go do it
                   00224 ;-----
0064              00225 LED_SEQ1
0064 078A          00226          BTFSS  LED_Mode,4    ;.2 ON, 1 OFF
                                ;Skip if bit is high
0065 0A76          00227          GOTO   ON1           ;Go do it
0066 0A82          00228          GOTO   OFF3          ;Go do it
                                ;-----
0067              00230 LED_SEQ2
                                ;.2 ON, .2 OFF, .2 ON, 1 OFF
0067 020A          00231          MOVF   LED_Mode,W
0068 0027          00232          MOVWF  temp
0069 0C30          00233          MOVLW  H'30'          ;Get sequence # only
006A 0167          00234          ANDWF  temp, F
006B 03A7          00235          SWAPF  temp, F       ;swap nibbles
006C 0207          00236          MOVF   temp,W         ;get nibble for offset
006D 01E2          00237          ADDWF  PCL, F         ;Table jump calculation
006E 0A76          00238          GOTO   ON1           ;LED is on, check if time to change
006F 0A7C          00239          GOTO   OFF2          ;LED is off, check if time to change
0070 0A76          00240          GOTO   ON1           ;LED is on, check if time to change
0071 0A82          00241          GOTO   OFF3          ;LED is off, check if time to change
                                ;-----
0072              00243 LED_Exit
0072 0C10          00244          MOVLW  H'10'          ;Inc Seq #
0073 01EA          00245          ADDWF  LED_Mode, F
0074 0070          00246          CLRF   LED_C          ;Reset LED_C
0075 0800          00247          RETLW  H'00'
0076              00248 ON1
0076 0C02          00249          MOVLW  H'02'          ;Check LED_C if time, .2 sec-on

```

```

0077 0090          00250      SUBWF   LED_C,W
0078 0743          00251      BTFSS  STATUS,Z
0079 0A47          00252      GOTO   _0012
007A 0425          00253      BCF    LED           ;Turn off LED
007B 0A72          00254      GOTO   LED_Exit
007C              00255  OFF2
007C 0C02          00256      MOVLW  H'02'         ;Check LED_C if time, .2 sec-on
007D 0090          00257      SUBWF   LED_C,W
007E 0743          00258      BTFSS  STATUS,Z
007F 0A47          00259      GOTO   _0012
0080 0525          00260      BSF    LED           ;Turn on LED
0081 0A72          00261      GOTO   LED_Exit
0082              00262  OFF3
0082 0C08          00263      MOVLW  H'08'         ;Check LED_C if time, 1 sec-off
0083 0090          00264      SUBWF   LED_C,W
0084 0743          00265      BTFSS  STATUS,Z
0085 0A47          00266      GOTO   _0012
0086 0525          00267      BSF    LED           ;Turn on LED
0087 0CF0          00268      MOVLW  H'F0'
0088 012A          00269      IORWF  LED_Mode, F  ;Cause (Seq# & NEW) to overflow to 0
0089 0A72          00270      GOTO   LED_Exit
008A              00271  LED_SEQ3 ;.2 ON, .2 OFF, .2 ON, .2 OFF, .2 ON, 1 OFF
008A 020A          00272      MOVF   LED_Mode,W   ;Get LED info
008B 0027          00273      MOVWF  temp
008C 0C70          00274      MOVLW  H'70'         ;Get sequence # only
008D 0167          00275      ANDWF  temp, F
008E 03A7          00276      SWAPF  temp, F      ;swap nibbles
008F 0207          00277      MOVF   temp,W       ;get nibble for offset
0090 01E2          00278      ADDWF  PCL, F       ;Table jump calculation
0091 0A76          00279      GOTO   ON1          ;LED is on check if time to change
0092 0A7C          00280      GOTO   OFF2         ;LED is off check if time to change
0093 0A76          00281      GOTO   ON1          ;LED is on check if time to change
0094 0A7C          00282      GOTO   OFF2         ;LED is off check if time to change
0095 0A76          00283      GOTO   ON1          ;LED is on check if time to change
0096 0A82          00284      GOTO   OFF3         ;LED is off check if time to change
0096              00285
0096              00286 ;**** Quick Check of Tasks #1, #2 and #3
0097              00287 QCheck_T123
0097              00288 ;Task #1 - Asynchronous 9600 Baud Serial Output (LOW=0)
0097 0708          00289      BTFSS  OState_B     ;if not outputting now then skip call
0098 0A9A          00290      GOTO   T2
0099 0902          00291      CALL   Do_OState    ;Go Do Task #1
0099              00292
0099              00293 ;Task #2 - Asynchronous 4800 Baud Serial Input (LOW=0)
009A 0628          00294  T2  BTFSC  IState1_B   ;if already started then call
009B 0A9F          00295      GOTO   _0029
009C 0605          00296      BTFSC  Serial_IN_1  ;if Start bit ? then call
009D 0A9F          00297      GOTO   _0029
009E 0AA0          00298      GOTO   T3
009F 09A7          00299  _0029 CALL   Do_I1State    ;Go Do Task #2
009F              00300
009F              00301 ;Task #3 - Asynchronous 4800 Baud Serial Input (LOW=0)
00A0 0648          00302  T3  BTFSC  IState2_B   ;if already started then call
00A1 0AA5          00303      GOTO   _0031
00A2 0665          00304      BTFSC  Serial_IN_2  ;if Start bit ? then call
00A3 0AA5          00305      GOTO   _0031
00A4 0800          00306      RETLW  H'00'
00A5 09C2          00307  _0031 CALL   Do_I2State    ;Go Do Task #3
00A6 0800          00308      RETLW  H'00'
00A6              00309
00A6              00310 ;***** ;Task #2 - Asynchronous 4800 Baud Serial Input (LOW=0)
00A7              00311 Do_I1State
00A7 0238          00312      MOVF   IState1, F   ;if IState1 == 0
00A8 0643          00313      BTFSC  STATUS,Z     ; then Do Start Bit
00A9 0ADD          00314      GOTO   I1StateS
00AA 0201          00315      MOVF   TMR0,W       ;Get current time

```

```

00AB 0027      00316      MOVWF  temp
00AC 0219      00317      MOVF   First_TMR0_I1,W ;Get elapsed time; Time Unit = 2 uS
00AD 00A7      00318      SUBWF  temp, F
00AE 021A      00319      MOVF   nbt11,W          ;Past time for next input bit ?
00AF 0087      00320      SUBWF  temp,W
00B0 0703      00321      BTFSS  STATUS,C
00B1 0AC1      00322      GOTO   _0033
00B2 0218      00323      MOVF   IState1,W       ;Get (0-B) mode #
00B3 0E0F      00324      ANDLW  H'0F'           ;Get only mode #
00B4 01E2      00325      ADDWF  PCL, F          ;jump to subroutine
00B5 0ADD      00326      GOTO   I1StateS        ;Serial Start Bit
00B6 0AE6      00327      GOTO   I1State2        ;1/2 of Start Bit - see if False Start
00B7 0AEF      00328      GOTO   I1State0_7      ;Bit 0
00B8 0AEF      00329      GOTO   I1State0_7      ;Bit 1
00B9 0AEF      00330      GOTO   I1State0_7      ;Bit 2
00BA 0AEF      00331      GOTO   I1State0_7      ;Bit 3
00BB 0AEF      00332      GOTO   I1State0_7      ;Bit 4
00BC 0AEF      00333      GOTO   I1State0_7      ;Bit 5
00BD 0AEF      00334      GOTO   I1State0_7      ;Bit 6
00BE 0AEF      00335      GOTO   I1State0_7      ;Bit 7
00BF 0AF8      00336      GOTO   I1StateE        ;Serial Stop Bit
00C0 0B03      00337      GOTO   I1StateL        ;Last State - End of Stop Bit
00C1           00338      _0033
00C1 0800      00339      RETLW  H'00'
                                00340
                                00341 ;***** ;Task #3 - Asynchronous 4800 Baud Serial Input (LOW=0)
00C2           00342 Do_I2State
00C2 023C      00343      MOVF   IState2, F     ;if IState1 == 0
00C3 0643      00344      BTFSC  STATUS,Z       ;then Do Start Bit
00C4 0B10      00345      GOTO   I2StateS
00C5 0201      00346      MOVF   TMR0,W         ;Get current time
00C6 0027      00347      MOVWF  temp
00C7 021D      00348      MOVF   First_TMR0_I2,W ;Get elapsed time; Time Unit = 2 uS
00C8 00A7      00349      SUBWF  temp, F
00C9 021E      00350      MOVF   nbt12,W        ;Past time for next input bit ?
00CA 0087      00351      SUBWF  temp,W
00CB 0703      00352      BTFSS  STATUS,C
00CC 0ADC      00353      GOTO   _0035
00CD 021C      00354      MOVF   IState2,W     ;Get (0-B) mode #
00CE 0E0F      00355      ANDLW  H'0F'           ;Get only mode #
00CF 01E2      00356      ADDWF  PCL, F          ;jump to subroutine
00D0 0B10      00357      GOTO   I2StateS        ;Serial Start Bit
00D1 0B19      00358      GOTO   I2StateS2      ;1/2 of Start Bit - see if False Start
00D2 0B22      00359      GOTO   I2State0_7     ;Bit 0
00D3 0B22      00360      GOTO   I2State0_7     ;Bit 1
00D4 0B22      00361      GOTO   I2State0_7     ;Bit 2
00D5 0B22      00362      GOTO   I2State0_7     ;Bit 3
00D6 0B22      00363      GOTO   I2State0_7     ;Bit 4
00D7 0B22      00364      GOTO   I2State0_7     ;Bit 5
00D8 0B22      00365      GOTO   I2State0_7     ;Bit 6
00D9 0B22      00366      GOTO   I2State0_7     ;Bit 7
00DA 0B2B      00367      GOTO   I2StateE        ;Serial Stop Bit
00DB 0B36      00368      GOTO   I2StateL        ;Last State - End of Stop Bit
00DC 0800      00369      _0035 RETLW  H'00'
                                00370
                                00371 ;*** ;Subroutines for Task #2
00DD           00372 I1StateS ;Start Bit - Setup timing variables
00DD 0528      00373      BSF   IState1_B       ;Serial Input Active
00DE 0201      00374      MOVF   TMR0,W         ;Store starting time
00DF 0039      00375      MOVWF  First_TMR0_I1
00E0 0C0D      00376      MOVLW  H'0D'           ;Fudge again
00E1 00B9      00377      SUBWF  First_TMR0_I1, F
00E2 0C32      00378      MOVLW  H'32'          ;Time delay = 1/2 bit time
00E3 003A      00379      MOVWF  nbt11
00E4 02B8      00380      INCF  IState1, F      ;Increment to next state
00E5 0800      00381      RETLW  H'00'

```

```

00E6          00382 I1State2          ;Check if still a Start Bit
00E6 0705    00383      BTFSS      Serial_IN_1      ;False Start Error ?
00E7 0B06    00384      GOTO        FS_Error_1
00E8 0409    00385      BCF          FS_Flag_1          ;Start Bit OK
00E9 021A    00386      MOVF         nbt1l,W          ;Adjust out the error
00EA 01F9    00387      ADDWF      First_TMR0_I1, F
00EB 0C64    00388      MOVLW     IN_BIT_TIME      ;Time Delay = full bit time
00EC 003A    00389      MOVWF     nbt1l
00ED 02B8    00390      INCF     IState1, F      ;increment to next state
00EE 0800    00391      RETLW    H'00'
00EF          00392 I1State0_7          ;Bit 0 - 7
00EF 0705    00393      BTFSS      Serial_IN_1      ;Move Input bit into C
00F0 0403    00394      BCF          STATUS,C
00F1 0605    00395      BTFSC     Serial_IN_1
00F2 0503    00396      BSF          STATUS,C
00F3 033B    00397      RRF          rcv_byte_1, F ;Move C into left most bit
00F4 021A    00398      MOVF         nbt1l,W
00F5 01F9    00399      ADDWF      First_TMR0_I1, F ;Adjust out the error
00F6 02B8    00400      INCF     IState1, F      ;increment to next state
00F7 0800    00401      RETLW    H'00'
00F8          00402 I1StateE          ;Check if we have a proper Stop Bit
00F8 0605    00403      BTFSC     Serial_IN_1      ;Frame Error
00F9 0B09    00404      GOTO        F_Error_1
00FA 0429    00405      BCF          FE_Flag_1      ;Stop Bit OK
00FB 006E    00406      CLRF       T_5_S_CO        ;Reset 5 Sec Timer - got a good byte
00FC 021B    00407      ;Process the msg Here !
00FC 021B    00408      MOVF         rcv_byte_1,W ;Make a copy of just received byte
00FD 0035    00409      MOVWF      RCV_Storage
00FE 07A8    00410      BTFSS     RCV_Got_One_B    ;Report Lost data
00FF 0489    00411      BCF          RCV_Overflow
0100 06A8    00412      BTFSC     RCV_Got_One_B
0101 0589    00413      BSF          RCV_Overflow
0102 05A8    00414      BSF          RCV_Got_One_B ;We Now have a RB Value to go out
0103          00415 I1StateL
0103 0078    00416      CLRF       IState1        ;Ready to receive next byte
0104 0428    00417      BCF          IState1_B     ;Serial In not currently active
0105 0800    00418      RETLW     H'00'
0106          00419 FS_Error_1          ;False Start - Shut Down Checking
0106 0428    00420      BCF          IState1_B     ;Serial Input NOT Active
0107 0509    00421      BSF          FS_Flag_1      ;False Start Error
0108 0B03    00422      GOTO        I1StateL
0109          00423 F_Error_1          ;Frame Error - Wait for End of Stop Bit
0109 021A    00424      MOVF         nbt1l,W      ;Adjust out the error
010A 01F9    00425      ADDWF      First_TMR0_I1, F
010B 0C32    00426      MOVLW     H'32'          ;Time Delay = 1/2 bit time
010C 003A    00427      MOVWF     nbt1l
010D 0529    00428      BSF          FE_Flag_1      ;Frame Error for this Byte ?
010E 02B8    00429      INCF     IState1, F      ;Increment to next state
010F 0800    00430      RETLW     H'00'
00431
00432 ;***          ;Subroutines for Task #3
0110          00433 I2States          ;Start Bit - Setup timing variables
0110 0548    00434      BSF          IState2_B     ;Serial Input Active
0111 0201    00435      MOVF         TMR0,W        ;Store starting time
0112 003D    00436      MOVWF      First_TMR0_I2
0113 0C0D    00437      MOVLW     H'0D'          ;Fudge again
0114 00BD    00438      SUBWF     First_TMR0_I2, F
0115 0C32    00439      MOVLW     H'32'          ;Time delay = 1/2 bit time
0116 003E    00440      MOVWF     nbt12
0117 02BC    00441      INCF     IState2, F      ;Increment to next state
0118 0800    00442      RETLW     H'00'
0119          00443 I2StatesS2        ;Check if still a Start Bit
0119 0765    00444      BTFSS     Serial_IN_2      ;False Start Error ?
011A 0B39    00445      GOTO        FS_Error_2
011B 0449    00446      BCF          FS_Flag_2      ;Start Bit OK
011C 021E    00447      MOVF         nbt12,W      ;Adjust out the error

```

```

011D 01FD          00448      ADDWF   First_TMR0_I2, F
011E 0C64          00449      MOVLW  IN_BIT_TIME      ;Time Delay = full bit time
011F 003E          00450      MOVWF  nbtI2
0120 02BC          00451      INCF   IState2, F      ;increment to next state
0121 0800          00452      RETLW  H'00'
0122              00453      I2State0_7            ;Bit 0 - 7
0122 0765          00454      BTFSS  Serial_IN_2     ;Move Input bit into C
0123 0403          00455      BCF    STATUS,C
0124 0665          00456      BTFSC  Serial_IN_2
0125 0503          00457      BSF    STATUS,C
0126 033F          00458      RRF    rcv_byte_2, F   ;Move C into left most bit
0127 021E          00459      MOVF   nbtI2,W
0128 01FD          00460      ADDWF  First_TMR0_I2, F ;Adjust out the error
0129 02BC          00461      INCF   IState2, F      ;increment to next state
012A 0800          00462      RETLW  H'00'
012B              00463      I2StateE             ;Check if we have a proper Stop Bit
012B 0665          00464      BTFSC  Serial_IN_2     ;Frame Error
012C 0B3C          00465      GOTO   F_Error_2
012D 0469          00466      BCF    FE_Flag_2       ;Stop Bit OK
012E 006E          00467      CLR    T_5_S_CO        ;Reset 5 Sec Timer - got a good byte
                                00468      ;Process the msg Here !
012F 021F          00469      MOVF   rcv_byte_2,W    ;Make a copy of just received byte
0130 0035          00470      MOVWF  RCV_Storage
0131 07A8          00471      BTFSS  RCV_Got_One_B   ;Report Lost data
0132 0489          00472      BCF    RCV_Overflow
0133 06A8          00473      BTFSC  RCV_Got_One_B
0134 0589          00474      BSF    RCV_Overflow
0135 05A8          00475      BSF    RCV_Got_One_B   ;We Now have a RB Value to go out
0136              00476      I2StateL
0136 007C          00477      CLR    IState2         ;Ready to receive next byte
0137 0448          00478      BCF    IState2_B       ;Serial In not currently active
0138 0800          00479      RETLW  H'00'
0139              00480      FS_Error_2
0139 0448          00481      BCF    IState2_B       ;False Start - Shut Down Checking
013A 0549          00482      BSF    FS_Flag_2       ;False Start Error
013B 0B36          00483      GOTO   I2StateL
013C              00484      F_Error_2
013C 021E          00485      MOVF   nbtI2,W        ;Adjust out the error
013D 01FD          00486      ADDWF  First_TMR0_I2, F
013E 0C32          00487      MOVLW  H'32'          ;Time Delay = 1/2 bit time
013F 003E          00488      MOVWF  nbtI2
0140 0569          00489      BSF    FE_Flag_2       ;Frame Error for this Byte ?
0141 02BC          00490      INCF   IState2, F      ;Increment to next state
0142 0800          00491      RETLW  H'00'
                                00492
0143              00493      ;*****             ;Code Starting point
0143 0C00          00494      Main
0143 0C00          00495      MOVLW  H'00'          ;What is High/Low for RA at INIT State
0144 0025          00496      MOVWF  PORTA
0145 0C00          00497      MOVLW  H'00'          ;What is High/Low for RB at INIT State
0146 0026          00498      MOVWF  PORTB
0147 0CF9          00499      MOVLW  H'F9'          ;RA TRIS at INIT State
0148 0005          00500      TRIS   5
0149 0CFF          00501      MOVLW  H'FF'          ;RB TRIS at INIT State
014A 0006          00502      TRIS   6
014B 0C00          00503      MOVLW  H'00'          ;TMR0/2
014C 0002          00504      OPTION
014D 0900          00505      CALL   Clear_Regs     ;Clear Registers 7-1F - Same Memory Page
014E 0061          00506      CLR    TMR0           ;Start timers
                                00507
                                00508      ;Initialize Tasks
014E 0061          00509                        ;Task #1 waits for byte to output
                                00510                        ;Task #2 waits for Serial IN Start Bit
                                00511                        ;Task #3 waits for Serial IN Start Bit
                                00512                        ;Task #4 runs when Task 1 is Not
                                00513                        ;Task #5 is always running

```

```

014F 0206      00514      MOVF      PORTB,W           ;Task #6 is Initialized here
0150 0036      00515      MOVWF     Old_RB
0151 0216      00516      MOVF      Old_RB,W         ;Make all the same initial value
0152 0037      00517      MOVWF     Last_RB
0153 05C8      00518      BSF       RB_NEW_B         ;Tell Task #4: RB byte ready to output
0154 0C08      00519      MOVLW     LED_OFF_MODE
0155 002A      00520      MOVWF     LED_Mode        ;Task #7 is Started
0156 0568      00521      BSF       T_5_S_B         ;Task #8 is Started here
0157 0588      00522      BSF       T_5_M_B         ;Task #9 is Started here
00523
00524 ; Handle Task & Timer activities - Main Loop
0158          00525 Task_1 ;Task #1 - Asynchronous 9600 Baud Serial Output (LOW=0)
0158 0708      00526      BTFSS     OState_B        ;if not outputing now then skip call
0159 0B5B      00527      GOTO      Task_2
015A 0902      00528      CALL     Do_OState        ;Go Do Task #1
00529
015B          00530 Task_2 ;Task #2 - Asynchronous 4800 Baud Serial Input (LOW=0)
015B 0628      00531      BTFSC     IState1_B       ;if already started then call
015C 0B60      00532      GOTO      _0053
015D 0605      00533      BTFSC     Serial_IN_1     ;if Start bit ? then call
015E 0B60      00534      GOTO      _0053
015F 0B61      00535      GOTO      Task_3
0160 09A7      00536 _0053 CALL     Do_I1State        ;Go Do Task #2
00537
0161          00538 Task_3 ;Task #3 - Asynchronous 4800 Baud Serial Input (LOW=0)
0161 0648      00539      BTFSC     IState2_B       ;if already started then call
0162 0B66      00540      GOTO      _0055
0163 0665      00541      BTFSC     Serial_IN_2     ;if Start bit ? then call
0164 0B66      00542      GOTO      _0055
0165 0B67      00543      GOTO      Task_4
0166 09C2      00544 _0055 CALL     Do_I2State        ;Go Do Task #3
00545
0167          00546 Task_4 ;Task #4 - Finds next Buffered Byte to Send Out through Task 1
0167 0608      00547      BTFSC     OState_B        ;if outputing now then skip call
0168 0B7D      00548      GOTO      _0059
0169 07A8      00549      BTFSS     RCV_Got_One_B   ;Got a NEW Received byte to send
016A 0B70      00550      GOTO      _0057
016B 0215      00551      MOVF      RCV_Storage,W   ;Send just received byte
016C 0033      00552      MOVWF     xmt_byte
016D 04A8      00553      BCF       RCV_Got_One_B   ;Clear need to send old byte
016E 0508      00554      BSF       OState_B        ;Start Task #1 & Lock Out Others
016F 0B7D      00555      GOTO      _0059
0170 07C8      00556 _0057 BTFSS     RB_NEW_B         ;Indicates a change in RB input
0171 0B77      00557      GOTO      _0058
0172 0216      00558      MOVF      Old_RB,W        ;Send New RB value
0173 0033      00559      MOVWF     xmt_byte
0174 04C8      00560      BCF       RB_NEW_B        ;Clear need to send out newest value
0175 0508      00561      BSF       OState_B        ;Start Task #1 & Lock Out Others
0176 0B7D      00562      GOTO      _0059
0177 07E8      00563 _0058 BTFSS     S_5_S_B         ;Serial In 5 secs of inactivity
0178 0B7D      00564      GOTO      _0059
0179 0CFF      00565      MOVLW     H'FF'           ;Tell of inactivity of Serial In
017A 0033      00566      MOVWF     xmt_byte
017B 04E8      00567      BCF       S_5_S_B        ;Clear need to send msg
017C 0508      00568      BSF       OState_B        ;Start Task #1 & Lock Out Others
00569
00570 ;Heart Beat - Time unit = 512 uS for Tasks #5 & #6
017D 0201      00571 _0059 MOVF      TMR0,W           ;Step-up time units * 512
017E 0027      00572      MOVWF     temp
017F 0211      00573      MOVF      Last_TMR0,W     ;Test to see if it overflowed
0180 0087      00574      SUBWF     temp,W
0181 0703      00575      BTFSS     STATUS,C
0182 0B86      00576      GOTO      Inc_Time
0183 0207      00577      MOVF      temp,W         ;unit error = < |+512 uS|
0184 0031      00578      MOVWF     Last_TMR0
0185 0B58      00579      GOTO      Task_1

```

AN585

```
0186          00580 Inc_Time
0186 0207      00581          MOVF    temp,W          ;Save current TMR0 into Last_TMR0
0187 0031      00582          MOVWF   Last_TMR0
00583
0188          00584 Task_5 ;Task #5 - Monitor Level Reset Input Line - Always Running !
0188 0606      00585          BTFSC   Level_Reset
0189 0B8C      00586          GOTO    Task_6
018A 0C08      00587          MOVLW   LED_OFF_MODE ;Lowest Level Indicator output
018B 002A      00588          MOVWF   LED_Mode
00589
018C          00590 Task_6 ;Task #6 - Debounce 8 bit Input Sensors - Runs every 20 mS
018C 02AF      00591          INCF    T_20_mS_CO, F ;Inc Counter - Time Unit = 512 uS
018D 0C27      00592          MOVLW   H'27' ;Used to debounce the input
018E 008F      00593          SUBWF   T_20_mS_CO,W
018F 0743      00594          BTFSS   STATUS,Z
0190 0BA7      00595          GOTO    _0065
0191 006F      00596          CLRFB   T_20_mS_CO ;Reset T_20_mS_CO to start over again
00597
0192 0997      00598          CALL    QCheck_T123 ;Quick Check of Tasks #1, #2 and #3
00599
0193 0206      00600          MOVFB   PORTB,W ;Last copy of RB same as Current ?
0194 0097      00601          SUBWF   Last_RB,W
0195 0643      00602          BTFSC   STATUS,Z
0196 0B9A      00603          GOTO    _0062
0197 0206      00604          MOVFB   PORTB,W ;Store Current RB - diff from Last
0198 0037      00605          MOVWF   Last_RB
0199 0B9C      00606          GOTO    _0063
019A 0217      00607 _0062 MOVFB   Last_RB,W ;New Old RB <- same value over 20 mS
019B 0036      00608          MOVWF   Old_RB
019C 0236      00609 _0063 MOVFB   Old_RB, F ;See if RB is now 0
019D 0643      00610          BTFSC   STATUS,Z ;RB == 0 ? then keep timer running
019E 0BA1      00611          GOTO    _0064
019F 006C      00612          CLRFB   T_5_M_LO ;Reset 5 Min Timer
01A0 006D      00613          CLRFB   T_5_M_HI ; still not zero yet
01A1 0901      00614 _0064 CALL    D_H_E_L ;Determine the Highest Error Level
01A2 07C8      00615          BTFSS   RB_NEW_B ;Check for Lost Data Error
01A3 04A9      00616          BCF     RB_Overflow
01A4 06C8      00617          BTFSC   RB_NEW_B
01A5 05A9      00618          BSFB   RB_Overflow
01A6 05C8      00619          BSFB   RB_NEW_B ;Every 20 mS send Old_RB out
00620
00621          ;Heart Beat - Time unit = 131072 uS for Tasks #7, #8 & #9
01A7 0CF9      00622 _0065 MOVLW   H'F9' ;RA TRIS - refresh
01A8 0005      00623          TRIS   5
01A9 0CFF      00624          MOVLW   H'FF' ;RB TRIS - refresh
01AA 0006      00625          TRIS   6
01AB 02F4      00626          DECFSZ cc, F ;Step-up time units * 256
01AC 0B58      00627          GOTO    Task_1
00628
01AD          00629 Task_7 ;Task 7 - Output Highest Level Indication on LED
01AD 076A      00630          BTFSS   LED_B ;Is LED active ?
01AE 0BB1      00631          GOTO    Task_8
00632
01AF 0997      00633          CALL    QCheck_T123 ;Quick Check of Tasks #1, #2 and #3
00634
01B0 0939      00635          CALL    Do_LED ;Handle LED timing
00636
01B1          00637 Task_8 ;Task #8 - 5 Second Serial Input Lack of Activity Timer
01B1 0768      00638          BTFSS   T_5_S_B ;5 Sec Timer Active ?
01B2 0BC0      00639          GOTO    Task_9
01B3 02AE      00640          INCF    T_5_S_CO, F ;Inc Counter - Time Unit = 131072 uS
01B4 0C26      00641          MOVLW   H'26' ;Check T_5_S_CO if time
01B5 008E      00642          SUBWF   T_5_S_CO,W
01B6 0743      00643          BTFSS   STATUS,Z
01B7 0BC0      00644          GOTO    Task_9
01B8 006E      00645          CLRFB   T_5_S_CO ;Reset T_5_S_CO
```



```

01B9 0C8F      00646      MOVLW    LED_ON_MODE      ;Highest Level Indicator output
01BA 002A      00647      MOVWF    LED_Mode
01BB 07E8      00648      BTFSS    S_5_S_B          ;Check if Lost Data Error
01BC 04C9      00649      BCF      S_5_S_Overflow
01BD 06E8      00650      BTFSC    S_5_S_B
01BE 05C9      00651      BSF      S_5_S_Overflow
01BF 05E8      00652      BSF      S_5_S_B          ;Send notice of 5 seconds of inaction
                                00653
01C0           00654      Task_9 ;Task #9 - 5 Min. Lack of Severe Error from Sensors Reset Timer
01C0 0788      00655      BTFSS    T_5_M_B          ;5 Min Timer Active ?
01C1 0BD1      00656      GOTO     Task_A
01C2 02AC      00657      INCF     T_5_M_LO, F      ;Inc LO Counter; Time Unit = 131072 uS
01C3 0643      00658      BTFSC    STATUS,Z         ;See if carry needs to be passed on ?
01C4 02AD      00659      INCF     T_5_M_HI, F      ;Inc HI Counter; Time Unit = 131072 uS
01C5 0C08      00660      MOVLW    H'08'           ;#2288< Check T_5_M_HI if time
01C6 008D      00661      SUBWF    T_5_M_HI,W
01C7 0743      00662      BTFSS    STATUS,Z
01C8 0BD1      00663      GOTO     Task_A
01C9 0CF0      00664      MOVLW    H'F0'           ;#2288> Check T_5_M_LO if time
01CA 008C      00665      SUBWF    T_5_M_LO,W
01CB 0743      00666      BTFSS    STATUS,Z
01CC 0BD1      00667      GOTO     Task_A
01CD 006C      00668      CLRF     T_5_M_LO         ;Reset T_5_M_LO
01CE 006D      00669      CLRF     T_5_M_HI         ;Reset T_5_M_HI
01CF 0C08      00670      MOVLW    LED_OFF_MODE    ;Lowest Level Indicator output
01D0 002A      00671      MOVWF    LED_Mode
01D1           00672      Task_A
01D1 0B58      00673      GOTO     Task_1          ;Loop Forever
                                00674
                                00675 ;****
01D2           00676      Do_D_H_E_L ; Determine the Highest Error Level & Start Task #7
01D2 0C07      00677      MOVLW    H'07'           ;Check top 7 bits
01D3 0027      00678      MOVWF    temp
01D4 0216      00679      MOVF     Old_RB,W        ;Get copy of 7 debounced Sensor Input
01D5 0037      00680      MOVWF    Last_RB
01D6 0377      00681      _0070    RLF      Last_RB, F      ;Put top bit into C bit
01D7 0603      00682      BTFSC    STATUS,C        ;Check if C bit is set
01D8 0BDE      00683      GOTO     _0072
01D9 02E7      00684      DECFSZ   temp, F        ;Continue to check lesser bits
01DA 0BD6      00685      GOTO     _0070
01DB 0206      00686      _0071    MOVF     PORTB,W        ;Restore current value of RB
01DC 0037      00687      MOVWF    Last_RB
01DD 0800      00688      RETLW    H'00'
01DE 020A      00689      _0072    MOVF     LED_Mode,W      ;Get current Level Indicator
01DF 0E07      00690      ANDLW    H'07'           ;Get only " "
01E0 0037      00691      MOVWF    Last_RB        ;Store into a temporary register
01E1 0207      00692      MOVF     temp,W          ;Check if already at this Level
01E2 0097      00693      SUBWF    Last_RB,W
01E3 0603      00694      BTFSC    STATUS,C
01E4 0BDB      00695      GOTO     _0071
01E5 0C88      00696      MOVLW    H'88'           ;Start to build LED_Mode
01E6 0107      00697      IORWF    temp,W          ;Put new Level Indicator into reg
01E7 002A      00698      MOVWF    LED_Mode        ;Store new LED Mode
01E8 0BDB      00699      GOTO     _0071
                                00700
01E9           00701      Do_Clear_Regs ; Clear Registers 7-1Fh
01E9 0C1F      00702      MOVLW    H'1F'           ;First regs to clear
01EA 0024      00703      MOVWF    FSR
01EB 0060      00704      Loop_C   CLRF    INDIR          ;Clear reg
01EC 00E4      00705      DECF     FSR, F          ;point to next reg to clear
01ED 0CE7      00706      MOVLW    H'E7'           ;Dec temp, jump if not done
01EE 0084      00707      SUBWF    FSR,W
01EF 0603      00708      BTFSC    STATUS,C
01F0 0BEB      00709      GOTO     Loop_C
01F1 0064      00710      CLRF     FSR             ;Lastly clear FSR reg
01F2 0800      00711      RETLW    H'00'

```

AN585

```
                                00712
01FF                            00713      ORG   H'1FF'      ;RESET to Main
01FF 0B43                       00714      GOTO   Main
                                00715
                                00716      END
```

MEMORY USAGE MAP ('X' = Used, '-' = Unused)

```
0000 : XXXXXXXXXXXXXXXXXXXX XXXXXXXXXXXXXXXXXXXX XXXXXXXXXXXXXXXXXXXX XXXXXXXXXXXXXXXXXXXX
0040 : XXXXXXXXXXXXXXXXXXXX XXXXXXXXXXXXXXXXXXXX XXXXXXXXXXXXXXXXXXXX XXXXXXXXXXXXXXXXXXXX
0080 : XXXXXXXXXXXXXXXXXXXX XXXXXXXXXXXXXXXXXXXX XXXXXXXXXXXXXXXXXXXX XXXXXXXXXXXXXXXXXXXX
00C0 : XXXXXXXXXXXXXXXXXXXX XXXXXXXXXXXXXXXXXXXX XXXXXXXXXXXXXXXXXXXX XXXXXXXXXXXXXXXXXXXX
0100 : XXXXXXXXXXXXXXXXXXXX XXXXXXXXXXXXXXXXXXXX XXXXXXXXXXXXXXXXXXXX XXXXXXXXXXXXXXXXXXXX
0140 : XXXXXXXXXXXXXXXXXXXX XXXXXXXXXXXXXXXXXXXX XXXXXXXXXXXXXXXXXXXX XXXXXXXXXXXXXXXXXXXX
0180 : XXXXXXXXXXXXXXXXXXXX XXXXXXXXXXXXXXXXXXXX XXXXXXXXXXXXXXXXXXXX XXXXXXXXXXXXXXXXXXXX
01C0 : XXXXXXXXXXXXXXXXXXXX XXXXXXXXXXXXXXXXXXXX XXXXXXXXXXXXXXXXXXXX XXX------X
```

All other memory blocks unused.

```
Program Memory Words Used:   500
Program Memory Words Free:    12
```

```
Errors   :      0
Warnings :    0 reported,    0 suppressed
Messages :    0 reported,    0 suppressed
```

Please check the Microchip BBS for the latest version of the source code. Microchip's Worldwide Web Address: www.microchip.com; Bulletin Board Support: MCHIPBBS using CompuServe® (CompuServe membership not required).

APPENDIX D:

MPASM 01.40 Released

APP_D.ASM 1-16-1997 17:10:05

PAGE 1

```

LOC OBJECT CODE      LINE SOURCE TEXT
VALUE
00001          list    p=16C64,t=ON,c=132
00002 ;
00003 ;*****
00004 ;
00005 ; 'Remote Alarm64' V1.00
00006 ;   Designed by Myriad Development Co. - Jerry Farmer
00007 ;   PIC16C64, 4MHz Crystal, WatchDog Timer OFF, MPASM instruction set
00008 ;   PIC16C54, 4MHz Crystal, WatchDog Timer OFF
00009 ;   Program:          APP_D.ASM
00010 ;   Revision Date:
00011 ;                               1-15-97   Compatibility with MPASMWIN 1.40
00012 ;
00013 ;*****
00014 ;
00015
00016          include "P16C64.INC"
00017          LIST
00018 ; P16C64.INC Standard Header File, Ver. 1.01 Microchip Technology, Inc.
00019          LIST
00020
00021 ; B Register Definitions
00022 Serial_IN_1    equ 0          ;Serial Input #1 - 8 bits - INT pin
00023              ;RB.7 - RB.1 == Input from Sensors
00024 RB_TRIS       equ B'11111111' ;RB TRIS at INIT State == all input
00025 RB_MASK        equ B'00000000' ;What is High/Low for RB at INIT State
00026
00027 ; A Register Definitions - Programmable Inputs
00028 Level_Reset    equ 0          ;PORTA.0 - Reset Level Indicator
00029 LED             equ 1          ;LED Output - Level/State Indicator
00030 Serial_Out      equ 2          ;Serial Output - 8 bits + passwords
00031 PWM_Out        equ 3          ;PWM Output - 8 bits ON, 8 bits OFF
00032
00033 RA_TRIS        equ B'11110001' ;RA TRIS at INIT State
00034 RA_MASK        equ B'00000000' ;What is High/Low for RA at INIT State
00035
00036 ; Register Files
00037 temp           equ 20h        ;Temporary holding register - PIC16C54/56
00038 tmp            equ 21h        ;Temporary reg
00039 Temp_W          equ 22h        ;Interrupt storage of W
00040 Temp_Stat      equ 23h        ;Interrupt storage of STATUS
00041 Temp_FSR       equ 24h        ;Interrupt storage of FSR
00042 T_B           equ 25h        ;Indicates which Timer(s) are Active = 1
00043 FLAGS         equ 26h        ;Error Flags
00044 LED_Mode      equ 27h        ;(0-2)=Mode, 3=LED_B, (4-6)=Seq #, 7=NEW
00045 OState        equ 28h        ;Serial Out State
00046 IState1       equ 29h        ;Serial In #1 State
00047 cc            equ 2Ah        ;256 * TMR0 time
00048 T_5_M_LO      equ 2Bh        ;5 Min Timer Counter - Low
00049 T_5_M_HI      equ 2Ch        ;5 Min Timer Counter - High
00050 T_5_S_CO      equ 2Dh        ;5 Second Timer - lack of Serial Input
00051 T_20_mS_CO   equ 2Eh        ;20 mS Timer - used for debouncing
00052 T_PWM_CO      equ 2Fh        ;PWM Counter
00053 LED_C          equ 30h        ;LED Counter
00054 xmt_byte      equ 31h        ;Serial xmit byte - destroyed in use

```

```

00000032      00052 rcv_byte_1      equ 32h ;Receive Serial #1 In byte
00000033      00053 RCV_Storage     equ 33h ;Long term storage of rcv_byte #1
00000034      00054 Old_RB         equ 34h ;Oldest/Master copy of RB
00000035      00055 Last_RB         equ 35h ;Last copy of RB
00000036      00056 PWM_ON          equ 36h ;PWM ON Counter
00000037      00057 PWM_OFF        equ 37h ;PWM OFF Counter
00000038      00058 PWM_tmp       equ 38h ;PWM temporary counter
00059
00060 ; Indicates which Timer(s) are Active = 1 & Flags - T_B
00000000      00061 OState_B       equ 0   ;Serial Out Active Bit
00000001      00062 IState1_B      equ 1   ;Serial IN #1 Active Bit
00000002      00063 T_5_S_B       equ 2   ;5 Second Timer Active Bit
00000003      00064 T_5_M_B       equ 3   ;5 Min Timer Active Bit
00000004      00065 RCV_Got_One_B equ 4   ;Got a NEW Received byte to send out
00000005      00066 RB_NEW_B       equ 5   ;Indicates a change in RB input
00000006      00067 S_5_S_B       equ 6   ;Serial In 5 secs of inactivity
00000007      00068 T_PWM_B       equ 7   ;PWM Activity Bit
00069
00070 ; Error Flags - FLAGS
00000000      00071 FS_Flag_1     equ 0   ;Serial #1 IN had a False Start Error
00000001      00072 FE_Flag_1     equ 1   ;Last Serial #1 IN had a Frame Error
00000002      00073 RCV_Overflow  equ 2   ;Lost Serial Input Byte - too Slow
00000003      00074 RB_Overflow   equ 3   ;Lost RB Input Byte - too Slow
00000004      00075 S_5_S_Overflow equ 4   ;Lost '5S Inactivity' msg - too Slow
00000005      00076 Time_Bit      equ 5   ;Indicate 512 uS has passed
00077
00078 ;Equates for LED Task #7 - LED_Mode
00000003      00079 LED_B         equ 3   ;LED is active - LED_Mode.3
00000007      00080 LED_NEW_B     equ 7   ;LED has just changed Modes = 1
00000008      00081 LED_OFF_MODE  equ B'00001000' ;LED OFF
00000009      00082 LED_SEQ1_MODE  equ B'10001001' ;LED Sequence 1: .2s On, 1s Off
00000008A     00083 LED_SEQ2_MODE  equ B'10001010' ;LED Sequence 2: 3x(.2s), 1s Off
00000008B     00084 LED_SEQ3_MODE  equ B'10001011' ;LED Sequence 3: 5x(.2s), 1s Off
00000009C     00085 LED_SLOW_MODE   equ B'10011100' ;LED Slow Pulsing - .3 Hz
00000009D     00086 LED_MEDIUM_MODE equ B'10011101' ;LED Medium Pulsing - 1 Hz
00000009E     00087 LED_FAST_MODE   equ B'10011110' ;LED Fast Pulsing - 3 Hz
00000008F     00088 LED_ON_MODE       equ B'10001111' ;LED ON Continuously
00089
0000          00090          ORG      0           ;Reset Vector
00091
0000 28F7     00092          GOTO    Main
00093
0004          00094          ORG      4           ;Interrupt Vector
00095
0004 29D4     00096          GOTO    Interrupt
00097
00098 ;***** Task #1 - Asynchronous 9600 Baud Serial Output (LOW=0)
0005          00099 Do_OState
0005 0828     00100          MOVF    OState,W           ;Get (0-A) mode #
0006 390F     00101          ANDLW  H'0F'           ;Get only mode #
0007 0782     00102          ADDWF  PCL, F           ;jump to subroutine
0008 2814     00103          GOTO   OStateS         ;Serial Start Bit
0009 2823     00104          GOTO   OState0_7       ;Bit 0
000A 2823     00105          GOTO   OState0_7       ;Bit 1
000B 2823     00106          GOTO   OState0_7       ;Bit 2
000C 2823     00107          GOTO   OState0_7       ;Bit 3
000D 2823     00108          GOTO   OState0_7       ;Bit 4
000E 2823     00109          GOTO   OState0_7       ;Bit 5
000F 2823     00110          GOTO   OState0_7       ;Bit 6
0010 2823     00111          GOTO   OState0_7       ;Bit 7
0011 2829     00112          GOTO   OStateE         ;Serial Stop Bit
0012 2831     00113          GOTO   OStateL         ;Last State
0013 0008     00114          RETURN
00115
0014          00116 OStateS
0014 3000     00117          MOVLW  H'00'           ;Post & Pre 1=1 & OFF

```

```

0015 0092          00118      MOVWF  T2CON
0016 1683          00119      BSF   STATUS,RP0      ;Point to BANK 1
0017 3053          00120      MOVLW H'68' - H'15'  ;104uS - 9600 Baud & adjust to Latency
Message[302]: Register in operand not in bank 0.  Ensure that bank bits are correct.
0018 0092          00121      MOVWF  PR2
0019 1283          00122      BCF   STATUS,RP0      ;Point to BANK 0
001A 0191          00123      CLRF  TMR2           ;Init to 0
001B 108C          00124      BCF   PIR1,TMR2IF    ;Clear Timer 2 Flag so as to start fresh
001C 1505          00125      BSF   PORTA,Serial_Out;Output 'Serial Start Bit' starting Now
001D 1512          00126      BSF   T2CON,TMR2ON   ;Start Timer 2
001E 0AA8          00127      INCF  OState, F     ;inc to next state BEFORE allowing interrupt
00128
001F 1683          00129      BSF   STATUS,RP0      ;Point to BANK 1
Message[302]: Register in operand not in bank 0.  Ensure that bank bits are correct.
0020 148C          00130      BSF   PIE1,TMR2IE    ;Allow for Timer 2 interrupts
0021 1283          00131      BCF   STATUS,RP0      ;Point to BANK 0
0022 0008          00132      RETURN
00133
0023              00134      OState0_7          ;Bit 0 - 7
0023 0CB1          00135      RRF   xmt_byte, F    ;Move bit into C from right most bit
0024 1C03          00136      BTFSS STATUS,C       ;Output C bit
0025 1105          00137      BCF   PORTA,Serial_Out ;
0026 1803          00138      BTFSC STATUS,C       ;
0027 1505          00139      BSF   PORTA,Serial_Out ;
0028 282A          00140      GOTO  OS_End
0029              00141      OStateE
0029 1105          00142      BCF   PORTA,Serial_Out ;Serial Stop Bit
002A 108C          00143      OS_End BCF   PIR1,TMR2IF    ;Clear Timer 2 Flag so as to start fresh
002B 1683          00144      BSF   STATUS,RP0      ;Point to BANK 1
002C 306C          00145      MOVLW H'68' + H'4    ;104uS - 9600 Baud & adjust to Latency
Message[302]: Register in operand not in bank 0.  Ensure that bank bits are correct.
002D 0092          00146      MOVWF  PR2
002E 1283          00147      BCF   STATUS,RP0      ;Point to BANK 0
002F 0AA8          00148      INCF  OState, F     ;increment to next state
0030 0008          00149      RETURN
0031              00150      OStateL
0031 1683          00151      BSF   STATUS,RP0      ;Point to BANK 1
Message[302]: Register in operand not in bank 0.  Ensure that bank bits are correct.
0032 108C          00152      BCF   PIE1,TMR2IE    ;Do NOT Allow Timer 2 interrupts
0033 1283          00153      BCF   STATUS,RP0      ;Point to BANK 0
00154
0034 108C          00155      BCF   PIR1,TMR2IF    ;Clear Timer 2 Flag so as to start fresh
0035 1112          00156      BCF   T2CON,TMR2ON   ;Stop Timer 2
0036 01A8          00157      CLRF  OState         ;Ready to send next byte out
0037 1025          00158      BCF   T_B,OState_B   ;Serial Out not active
0038 0008          00159      RETURN
00160
00161 ;***** Task #7 - Output Highest Level Indication on LED
0039              00162      Do_LED
0039 1BA7          00163      BTFSC LED_Mode,LED_NEW_B;Initialize regs if change in modes
003A 284C          00164      GOTO  LED_NEW
003B 0AB0          00165      INCF  LED_C, F       ;Inc Counter - Time Unit = 131072 uS
003C 0827          00166      MOVF  LED_Mode,W     ;Get (0-7) mode #
003D 3907          00167      ANDLW H'07'         ;Get only mode #
003E 0782          00168      ADDWF PCL, F         ;jump to subroutine
003F 2848          00169      GOTO  LED_OFF        ;LED OFF
0040 2864          00170      GOTO  LED_SEQ1       ;LED Seq 1: 1 short pulse & pause
0041 2867          00171      GOTO  LED_SEQ2       ;LED Seq 2: 2 short pulses & pause
0042 288A          00172      GOTO  LED_SEQ3       ;LED Seq 3: 3 short pulses & pause
0043 2850          00173      GOTO  LED_SLOW       ;LED Slow Pulsing - .3 Hz
0044 285E          00174      GOTO  LED_MEDIUM     ;LED Medium Pulsing - 1 Hz
0045 2861          00175      GOTO  LED_FAST       ;LED Fast Pulsing - 3 Hz
0046 284D          00176      GOTO  LED_ON         ;LED ON Continuously
0047 0008          00177      _0012 RETURN
00178 ;-----
0048              00179      LED_OFF

```

AN585

```
0048 1085      00180      BCF      PORTA,LED      ;Turn off LED
0049 11A7      00181      BCF      LED_Mode,LED_B ;LED must be off
004A 01B0      00182      CLRF     LED_C          ;Reset Counter - LED_C = 0
004B 0008      00183      RETURN
00184 ;-----
004C          00185 LED_NEW
004C 13A7      00186      BCF      LED_Mode,LED_NEW_B ;Done initializing
004D          00187 LED_ON
004D 1485      00188      BSF      PORTA,LED      ;Turn on LED
004E 01B0      00189      CLRF     LED_C          ;Reset Counter - LED_C = 0
004F 0008      00190      RETURN
00191 ;-----
0050          00192 LED_SLOW
0050 300C      00193      MOVLW   H'0C'          ;.3Hz @ 50% Duty
0051 00A0      00194      MOVWF   temp
0052 0820      00195 LED_S      MOVF    temp,W          ;Check LED_C if time, .3Hz @ 50% Duty
0053 0230      00196      SUBWF   LED_C,W
0054 1D03      00197      BTFSS   STATUS,Z
0055 2847      00198      GOTO    _0012
0056 3010      00199      MOVLW   H'10'
0057 06A7      00200      XORWF   LED_Mode, F    ;Switch states
0058 1E27      00201      BTFSS   LED_Mode,4     ;Now make LED same state
0059 1085      00202      BCF     PORTA,LED
005A 1A27      00203      BTFSC   LED_Mode,4
005B 1485      00204      BSF     PORTA,LED
005C 01B0      00205      CLRF    LED_C          ;Reset LED_C
005D 0008      00206      RETURN
00207 ;-----
005E          00208 LED_MEDIUM
005E 3004      00209      MOVLW   H'04'          ;1Hz @ 50% Duty
005F 00A0      00210      MOVWF   temp
0060 2852      00211      GOTO    LED_S          ;Go do it
00212 ;-----
0061          00213 LED_FAST
0061 3001      00214      MOVLW   H'01'          ;3Hz @ 50% Duty
0062 00A0      00215      MOVWF   temp
0063 2852      00216      GOTO    LED_S          ;Go do it
00217 ;-----
0064          00218 LED_SEQ1
0064 1E27      00219      BTFSS   LED_Mode,4     ;.2 ON, 1 OFF
0065 2876      00220      GOTO    ON1            ;Skip if bit is high
0066 2882      00221      GOTO    OFF3           ;Go do it
00222 ;-----
0067          00223 LED_SEQ2
0067 0827      00224      MOVF    LED_Mode,W     ;.2 ON, .2 OFF, .2 ON, 1 OFF
0068 00A0      00225      MOVWF   temp
0069 3030      00226      MOVLW   H'30'          ;Get sequence # only
006A 05A0      00227      ANDWF   temp, F
006B 0EA0      00228      SWAPF   temp, F        ;swap nibbles
006C 0820      00229      MOVF    temp,W          ;get nibble for offset
006D 0782      00230      ADDWF   PCL, F         ;Table jump calculation
006E 2876      00231      GOTO    ON1            ;LED is on, check if time to change
006F 287C      00232      GOTO    OFF2           ;LED is off, check if time to change
0070 2876      00233      GOTO    ON1            ;LED is on, check if time to change
0071 2882      00234      GOTO    OFF3           ;LED is off, check if time to change
00235 ;-----
0072          00236 LED_Exit
0072 3010      00237      MOVLW   H'10'          ;Inc Seq #
0073 07A7      00238      ADDWF   LED_Mode, F
0074 01B0      00239      CLRF    LED_C          ;Reset LED_C
0075 0008      00240      RETURN
0076          00241 ON1
0076 3002      00242      MOVLW   H'02'          ;Check LED_C if time, .2 sec-on
0077 0230      00243      SUBWF   LED_C,W
0078 1D03      00244      BTFSS   STATUS,Z
0079 2847      00245      GOTO    _0012
```

```

007A 1085      00246      BCF      PORTA,LED      ;Turn off LED
007B 2872      00247      GOTO     LED_Exit
007C           00248 OFF2
007C 3002      00249      MOVLW   H'02'          ;Check LED_C if time, .2 sec-on
007D 0230      00250      SUBWF   LED_C,W
007E 1D03      00251      BTFSS   STATUS,Z
007F 2847      00252      GOTO    _0012
0080 1485      00253      BSF     PORTA,LED      ;Turn on LED
0081 2872      00254      GOTO    LED_Exit
0082           00255 OFF3
0082 3008      00256      MOVLW   H'08'          ;Check LED_C if time, 1 sec-off
0083 0230      00257      SUBWF   LED_C,W
0084 1D03      00258      BTFSS   STATUS,Z
0085 2847      00259      GOTO    _0012
0086 1485      00260      BSF     PORTA,LED      ;Turn on LED
0087 30F0      00261      MOVLW   H'F0'
0088 04A7      00262      IORWF   LED_Mode, F    ;Cause (Seq# & NEW) to overflow to 0
0089 2872      00263      GOTO    LED_Exit
008A           00264 LED_SEQ3      ;.2 ON, .2 OFF, .2 ON, .2 OFF, .2 ON, 1 OFF
008A 0827      00265      MOVF    LED_Mode,W     ;Get LED info
008B 00A0      00266      MOVWF   temp
008C 3070      00267      MOVLW   H'70'          ;Get sequence # only
008D 05A0      00268      ANDWF   temp, F
008E 0EA0      00269      SWAPF   temp, F       ;swap nibbles
008F 0820      00270      MOVF    temp,W         ;get nibble for offset
0090 0782      00271      ADDWF   PCL, F        ;Table jump calculation
0091 2876      00272      GOTO    ON1            ;LED is on check if time to change
0092 287C      00273      GOTO    OFF2           ;LED is off check if time to change
0093 2876      00274      GOTO    ON1            ;LED is on check if time to change
0094 287C      00275      GOTO    OFF2           ;LED is off check if time to change
0095 2876      00276      GOTO    ON1            ;LED is on check if time to change
0096 2882      00277      GOTO    OFF3           ;LED is off check if time to change
0097           00278
0097           00279 ;*****      Task #2 - Asynchronous 4800 Baud Serial Input (LOW=0)
0097 0829      00280 Do_I1State
0097 0829      00281      MOVF    IState1,W     ;Get (0-B) mode #
0098 390F      00282      ANDLW   H'0F'          ;Get only mode #
0099 0782      00283      ADDWF   PCL, F        ;jump to subroutine
009A 28A7      00284      GOTO    I1StateS      ;Serial Start Bit
009B 28B8      00285      GOTO    I1State2      ;1/2 of Start Bit - see if False Start
009C 28C5      00286      GOTO    I1State0_7    ;Bit 0
009D 28C5      00287      GOTO    I1State0_7    ;Bit 1
009E 28C5      00288      GOTO    I1State0_7    ;Bit 2
009F 28C5      00289      GOTO    I1State0_7    ;Bit 3
00A0 28C5      00290      GOTO    I1State0_7    ;Bit 4
00A1 28C5      00291      GOTO    I1State0_7    ;Bit 5
00A2 28C5      00292      GOTO    I1State0_7    ;Bit 6
00A3 28C5      00293      GOTO    I1State0_7    ;Bit 7
00A4 28D4      00294      GOTO    I1StateE      ;Serial Stop Bit
00A5 28DF      00295      GOTO    I1StateL      ;Last State - End of Stop Bit
00A6 0008      00296      RETURN
0097           00297
0097           00298 ;***      Subroutines for Task #2
00A7 120B      00299 I1StateS      ;Start Bit - Setup timing variables
00A7 120B      00300      BCF     INTCON,INTE    ;Disable detecting changes on INT pin
00A8 108B      00301      BCF     INTCON,INTF    ;Clear Interrupting Flag
00A9 3000      00302      MOVLW   H'00'          ;Internal Clk, Pre 1=1 & OFF
00AA 0090      00303      MOVWF   T1CON
00AB 018E      00304      CLRF    TMR1L          ;Calculate (0 - #) of counts until roll-over
00AC 304A      00305      MOVLW   H'68' - H'1E' ;208us/2 = 4800 Baud & adjust to Latency
00AD 028E      00306      SUBWF   TMR1L, F
00AE 018F      00307      CLRF    TMR1H
00AF 038F      00308      DECF    TMR1H, F      ;H'FF'
00B0 100C      00309      BCF     PIR1,TMR1IF    ;Clear Timer 1 Flag so as to start fresh
00B1 1410      00310      BSF     T1CON,TMR1ON   ;Start Timer 1
00B2 0AA9      00311      INCF    IState1, F    ;inc to next state BEFORE allowing interrupts

```

```

00B3 14A5      00312      BSF      T_B,IState1_B   ;Serial Input Active
                00313
00B4 1683      00314      BSF      STATUS,RP0    ;Point to BANK 1
Message[302]: Register in operand not in bank 0.  Ensure that bank bits are correct.
00B5 140C      00315      BSF      PIE1,TMR1IE   ;Allow for Timer 1 interrupts
00B6 1283      00316      BCF      STATUS,RP0    ;Point to BANK 0
00B7 0008      00317      RETURN
00B8           00318      I1State2                ;Check if still a Start Bit
00B8 1C06      00319      BTFSS   PORTB,Serial_IN_1 ;False Start Error ?
00B9 28E9      00320      GOTO    FS_Error_1
00BA 1026      00321      BCF      FLAGS,FS_Flag_1 ;Start Bit OK
00BB 1010      00322      BCF      T1CON,TMR1ON   ;Stop Timer 1
00BC 018E      00323      CLRF    TMR1L
00BD 30AA      00324      MOVLW   H'D0' - H'26'   ;208us = 4800 Baud & adjust to Latency
00BE 028E      00325      SUBWF   TMR1L, F
00BF 018F      00326      CLRF    TMR1H
00C0 038F      00327      DECF    TMR1H, F        ;H'FF'
00C1 100C      00328      BCF     PIR1,TMR1IF     ;Clear Timer 1 Flag so as to start fresh
00C2 1410      00329      BSF     T1CON,TMR1ON   ;Start Timer 1
00C3 0AA9      00330      INCF    IState1, F     ;increment to next state
00C4 0008      00331      RETURN
00C5           00332      I1State0_7              ;Bit 0 - 7
00C5 1C06      00333      BTFSS   PORTB,Serial_IN_1 ;Move Input bit into C
00C6 1003      00334      BCF     STATUS,C
00C7 1806      00335      BTFSC   PORTB,Serial_IN_1
00C8 1403      00336      BSF     STATUS,C
00C9 0CB2      00337      RRF     rcv_byte_1, F   ;Move C into left most bit
00CA 1010      00338      BCF     T1CON,TMR1ON   ;Stop Timer 1
00CB 018E      00339      CLRF    TMR1L
00CC 30AA      00340      MOVLW   H'D0' - H'26'   ;208us = 4800 Baud & adjust to Latency
00CD 028E      00341      SUBWF   TMR1L, F
00CE 018F      00342      CLRF    TMR1H
00CF 038F      00343      DECF    TMR1H, F        ;H'FF'
00D0 100C      00344      BCF     PIR1,TMR1IF     ;Clear Timer 1 Flag so as to start fresh
00D1 1410      00345      BSF     T1CON,TMR1ON   ;Start Timer 1
00D2 0AA9      00346      INCF    IState1, F     ;increment to next state
00D3 0008      00347      RETURN
00D4           00348      I1StateE                ;Check if we have a proper Stop Bit
00D4 1806      00349      BTFSC   PORTB,Serial_IN_1 ;Frame Error
00D5 28EC      00350      GOTO    F_Error_1
00D6 10A6      00351      BCF     FLAGS,FE_Flag_1 ;Stop Bit OK
00D7 01AD      00352      CLRF    T_5_S_CO       ;Reset 5 Sec Timer - got a good byte
                00353      ;Process the msg Here !
00D8 0832      00354      MOVF    rcv_byte_1,W    ;Make a copy of just received byte
00D9 00B3      00355      MOVWF   RCV_Storage
00DA 1E25      00356      BTFSS   T_B,RCV_Got_One_B ;Report Lost data
00DB 1126      00357      BCF     FLAGS,RCV_Overflow
00DC 1A25      00358      BTFSC   T_B,RCV_Got_One_B
00DD 1526      00359      BSF     FLAGS,RCV_Overflow
00DE 1625      00360      BSF     T_B,RCV_Got_One_B ;We Now have a RB Value to go out
00DF           00361      I1StateL
00DF 1010      00362      BCF     T1CON,TMR1ON   ;Stop Timer 1
00E0 1683      00363      BSF     STATUS,RP0    ;Point to BANK 1
Message[302]: Register in operand not in bank 0.  Ensure that bank bits are correct.
00E1 140C      00364      BSF     PIE1,TMR1IE   ;Allow for Timer 1 interrupts
00E2 1283      00365      BCF     STATUS,RP0    ;Point to BANK 0
00E3 100C      00366      BCF     PIR1,TMR1IF     ;Clear Timer 1 Flag so as to start fresh
                00367
00E4 01A9      00368      CLRF    IState1        ;Ready to receive next byte
00E5 10A5      00369      BCF     T_B,IState1_B   ;Serial In not currently active
                00370
00E6 108B      00371      BCF     INTCON,INTF     ;Clear Interrupting Flag
00E7 160B      00372      BSF     INTCON,INTE     ;Enable detecting changes on INT pin
00E8 0008      00373      RETURN
00E9           00374      FS_Error_1              ;False Start - Shut Down Checking
00E9 10A5      00375      BCF     T_B,IState1_B   ;Serial Input NOT Active

```



```

00EA 1426      00376      BSF      FLAGS,FS_Flag_1      ;False Start Error
00EB 28DF      00377      GOTO     I1StateL      ;Start All Over
00EC          00378      F_Error_1      ;Frame Error - Wait for End of Stop Bit
00EC 14A6      00379      BSF      FLAGS,FE_Flag_1      ;Frame Error for this Byte ?
00ED 0AA9      00380      INCF     IState1, F      ;Increment to next state
00EE 1010      00381      BCF      T1CON,TMR1ON      ;Stop Timer 1
00EF 018E      00382      CLRF     TMR1L
00F0 304A      00383      MOVLW   H'68' - H'1E'      ;208us/2 = 4800 Baud & adjust to Latency
00F1 028E      00384      SUBWF   TMR1L, F
00F2 018F      00385      CLRF     TMR1H
00F3 038F      00386      DECF     TMR1H, F      ;H'FF'
00F4 100C      00387      BCF      PIR1,TMR1IF      ;Clear Timer 1 Flag so as to start fresh
00F5 1410      00388      BSF      T1CON,TMR1ON      ;Start Timer 1
00F6 0008      00389      RETURN
00390
00391 ;*****      Code Starting point
00F7          00392      Main
00F7 0183      00393      CLRF     STATUS
00F8 0184      00394      CLRF     FSR
00F9 0181      00395      CLRF     TMR0      ;Clear Timer0
00FA 3000      00396      MOVLW   H'00'      ;What is High/Low for RA at RESET State
00FB 0085      00397      MOVWF   PORTA
00FC 0086      00398      MOVWF   PORTB
00FD 0087      00399      MOVWF   PORTC
00FE 0088      00400      MOVWF   PORTD
00FF 0089      00401      MOVWF   PORTE
0100 018A      00402      CLRF     PCLATH
0101 3060      00403      MOVLW   H'60'      ;/GIE,PEIE,TOIE,/INTE,/RBIE,/TOIF,/INTF,/RBIF
0102 008B      00404      MOVWF   INTCON
0103 018C      00405      CLRF     PIR1      ;Timer 2 Flag cleared
0104 018E      00406      CLRF     TMR1L
0105 018F      00407      CLRF     TMR1H
0106 0190      00408      CLRF     T1CON      ;Timer 1 OFF until ready for input
0107 0191      00409      CLRF     TMR2
0108 0192      00410      CLRF     T2CON      ;Timer 2 OFF until have byte to output
0109 0193      00411      CLRF     SSPBUF
010A 0194      00412      CLRF     SSPCON
010B 0195      00413      CLRF     CCP1L
010C 0196      00414      CLRF     CCP1H
010D 0197      00415      CLRF     CCP1CON
00416
010E 1683      00417      BSF      STATUS,RP0      ;Point to BANK 1
010F 3040      00418      MOVLW   H'40'      ;TMR0/2 & Interrupt on Rising edge of INT
Message[302]: Register in operand not in bank 0. Ensure that bank bits are correct.
0110 0081      00419      MOVWF   OPTION_REG      ;Load OPTION reg
0111 30F1      00420      MOVLW   RA_TRIS
Message[302]: Register in operand not in bank 0. Ensure that bank bits are correct.
0112 0085      00421      MOVWF   TRISA
0113 30FF      00422      MOVLW   H'FF'      ;RB TRIS at RESET State
Message[302]: Register in operand not in bank 0. Ensure that bank bits are correct.
0114 0086      00423      MOVWF   TRISB
Message[302]: Register in operand not in bank 0. Ensure that bank bits are correct.
0115 0087      00424      MOVWF   TRISC
Message[302]: Register in operand not in bank 0. Ensure that bank bits are correct.
0116 0088      00425      MOVWF   TRISD
0117 3007      00426      MOVLW   H'07'      ;PSPMODE=0
Message[302]: Register in operand not in bank 0. Ensure that bank bits are correct.
0118 0089      00427      MOVWF   TRISE
Message[302]: Register in operand not in bank 0. Ensure that bank bits are correct.
0119 018C      00428      CLRF     PIE1      ;Timer 2 Interrupt disabled
Message[302]: Register in operand not in bank 0. Ensure that bank bits are correct.
011A 148E      00429      BSF      PCON,NOT_POR
Message[302]: Register in operand not in bank 0. Ensure that bank bits are correct.
011B 0192      00430      CLRF     PR2
Message[302]: Register in operand not in bank 0. Ensure that bank bits are correct.
011C 0193      00431      CLRF     SSPADD

```

Message[302]: Register in operand not in bank 0. Ensure that bank bits are correct.

```

011D 0194      00432      CLRF      SSPSTAT
                00433
011E 1283      00434      BCF      STATUS,RP0 ;Point to BANK 0
011F 21BF      00435      CALL     Clear_Regs ;Clear Registers 20-7F, A0-C0 Memory Pages
                00436
                00437 ;Initialize Tasks
                00438 ;Task #1 waits for byte to output
                00439 ;Task #2 waits for Serial IN Start Bit
0120 3031      00440      MOVLW   H'31'      ;Task #3 is initialized for square pulses
0121 00B6      00441      MOVWF   PWM_ON      ; " 25 mS ON
0122 3031      00442      MOVLW   H'31'      ; " Period = 50 mS, DS= 50%
0123 00B7      00443      MOVWF   PWM_OFF     ; " 25 mS OFF
0124 01AF      00444      CLRF    T_PWM_CO    ; "
0125 0836      00445      MOVF    PWM_ON,W    ;move PWM_tmp,PWM_ON
0126 00B8      00446      MOVWF   PWM_tmp     ; "
0127 1585      00447      BSF     PORTA,PWM_Out ;Start Outputting ON
0128 17A5      00448      BSF     T_B,T_PWM_B  ; "
                00449 ;Task #4 runs when Task 1 is Not
                00450 ;Task #5 is always running
0129 0806      00451      MOVF    PORTB,W    ;Task #6 is Initialized here
012A 00B4      00452      MOVWF   Old_RB
012B 0834      00453      MOVF    Old_RB,W    ;Make all the same initial value
012C 00B5      00454      MOVWF   Last_RB
012D 16A5      00455      BSF     T_B,RB_NEW_B ;Tell Task #4: RB byte ready to output
012E 3008      00456      MOVLW   LED_OFF_MODE
012F 00A7      00457      MOVWF   LED_Mode   ;Task #7 is Started
0130 1525      00458      BSF     T_B,T_5_S_B  ;Task #8 is Started here
0131 15A5      00459      BSF     T_B,T_5_M_B  ;Task #9 is Started here
                00460
0132 178B      00461      BSF     INTCON,GIE   ;Enable Global Interrupts
                00462
                00463 ; Handle Task & Timer activities - Main Loop done in background
0133          00464 Inc_Time ;Heart Beat - Time unit = 512 uS for Tasks #5 & #6
0133 1EA6      00465      BTFSS   FLAGS,Time_Bit ;Idle Task - wait until 512 uS has gone by
0134 2933      00466      GOTO    Inc_Time
0135 12A6      00467      BCF     FLAGS,Time_Bit ;Reset for next indicator
                00468 ;from TMR0 Interrupt
0136          00469 Task_3 ;Task #3 - PWM, Period = (PWM_ON + PWM_OFF) * 512uS
0136 1FA5      00470      BTFSS   T_B,T_PWM_B  ;if NOT outputting now then skip call
0137 2947      00471      GOTO    Task_4
0138 0AAF      00472      INCF    T_PWM_CO, F ;Inc count of time
0139 0838      00473      MOVF    PWM_tmp,W    ;cjne T_PWM_CO,PWM_tmp,Task_4
013A 022F      00474      SUBWF   T_PWM_CO,W   ; "
013B 1D03      00475      BTFSS   STATUS,Z    ; "
013C 2947      00476      GOTO    Task_4      ; "
013D 01AF      00477      CLRF    T_PWM_CO    ;Reset timer
013E 1985      00478      BTFSC   PORTA,PWM_Out
013F 2944      00479      GOTO    T3_1
0140 1585      00480      BSF     PORTA,PWM_Out ;Change Output State
0141 0836      00481      MOVF    PWM_ON,W    ;move PWM_tmp,PWM_ON
0142 00B8      00482      MOVWF   PWM_tmp     ; "
0143 2947      00483      GOTO    Task_4
0144          00484 T3_1
0144 1185      00485      BCF     PORTA,PWM_Out ;Change Output State
0145 0837      00486      MOVF    PWM_OFF,W   ;mov PWM_tmp,PWM_OFF
0146 00B8      00487      MOVWF   PWM_tmp     ; "
                00488
0147          00489 Task_4 ;Task #4 - Finds next Buffered Byte to Send Out through Task 1
0147 1825      00490      BTFSC   T_B,OState_B ;if outputting now then skip call
0148 295E      00491      GOTO    Task_5
0149 1E25      00492      BTFSS   T_B,RCV_Got_One_B ;Got a NEW Received byte to send
014A 2950      00493      GOTO    _0057
014B 0833      00494      MOVF    RCV_Storage,W ;Send just received byte
014C 00B1      00495      MOVWF   xmt_byte
014D 1225      00496      BCF     T_B,RCV_Got_One_B ;Clear need to send old byte

```

```

014E 1425      00497      BSF      T_B,OState_B      ;Start Task #1 & Lock Out Others
014F 295D      00498      GOTO     T4_S
0150 1EA5      00499      _0057   BTFSS    T_B,RB_NEW_B      ;Indicates a change in RB input
0151 2957      00500      GOTO     _0058
0152 0834      00501      MOVF     Old_RB,W          ;Send New RB value
0153 00B1      00502      MOVWF    xmt_byte
0154 12A5      00503      BCF      T_B,RB_NEW_B      ;Clear need to send out newest value
0155 1425      00504      BSF      T_B,OState_B      ;Start Task #1 & Lock Out Others
0156 295D      00505      GOTO     T4_S
0157 1F25      00506      _0058   BTFSS    T_B,S_5_S_B      ;Serial In 5 secs of inactivity
0158 295E      00507      GOTO     Task_5
0159 30FF      00508      MOVLW    H'FF'            ;Tell of inactivity of Serial In
015A 00B1      00509      MOVWF    xmt_byte
015B 1325      00510      BCF      T_B,S_5_S_B      ;Clear need to send msg
015C 1425      00511      BSF      T_B,OState_B      ;Start Task #1 & Lock Out Others
015D           00512      T4_S
015D 2005      00513      CALL     Do_OState
00514
015E           00515      Task_5 ;Task #5 - Monitor Level Reset Input Line - Always Running !
015E 1805      00516      BTFSC    PORTA,Level_Reset
015F 2962      00517      GOTO     Task_6
0160 3008      00518      MOVLW    LED_OFF_MODE      ;Lowest Level Indicator output
0161 00A7      00519      MOVWF    LED_Mode
00520
0162           00521      Task_6 ;Task #6 - Debounce 8 bit Input Sensors - Runs every 20 mS
0162 0AAE      00522      INCF     T_20_mS_CO, F      ;Inc Counter - Time Unit = 512 uS
0163 3027      00523      MOVLW    H'27'            ;Used to debounce the input
0164 022E      00524      SUBWF    T_20_mS_CO,W
0165 1D03      00525      BTFSS    STATUS,Z
0166 297C      00526      GOTO     _0065
0167 01AE      00527      CLRF     T_20_mS_CO        ;Reset T_20_mS_CO to start over again
0168 0806      00528      MOVF     PORTB,W          ;Last copy of RB same as Current ?
0169 0235      00529      SUBWF    Last_RB,W
016A 1903      00530      BTFSC    STATUS,Z
016B 296F      00531      GOTO     _0062
016C 0806      00532      MOVF     PORTB,W          ;Store Current RB - diff from Last
016D 00B5      00533      MOVWF    Last_RB
016E 2971      00534      GOTO     _0063
016F 0835      00535      _0062   MOVF     Last_RB,W          ;New Old RB <- same value over 20 mS
0170 00B4      00536      MOVWF    Old_RB
0171 08B4      00537      _0063   MOVF     Old_RB, F          ;See if RB is now 0
0172 1903      00538      BTFSC    STATUS,Z          ;RB == 0 ? then keep timer running
0173 2976      00539      GOTO     _0064
0174 01AB      00540      CLRF     T_5_M_LO          ;Reset 5 Min Timer
0175 01AC      00541      CLRF     T_5_M_HI          ; still not zero yet
0176 21A8      00542      _0064   CALL     D_H_E_L          ;Determine the Highest Error Level
0177 1EA5      00543      BTFSS    T_B,RB_NEW_B      ;Check for Lost Data Error
0178 11A6      00544      BCF      FLAGS,RB_Overflow
0179 1AA5      00545      BTFSC    T_B,RB_NEW_B
017A 15A6      00546      BSF      FLAGS,RB_Overflow
017B 16A5      00547      BSF      T_B,RB_NEW_B      ;Every 20 mS send Old_RB out
00548
00549      ;Heart Beat - Time unit = 131072 uS for Tasks #7, #8 & #9
017C           00550      _0065
017C 1683      00551      BSF      STATUS,RP0        ;Point to BANK 1
017D 30F1      00552      MOVLW    RA_TRIS          ;RA TRIS - refresh
Message[302]: Register in operand not in bank 0. Ensure that bank bits are correct.
017E 0085      00553      MOVWF    TRISA
017F 30FF      00554      MOVLW    H'FF'            ;RB TRIS - refresh
Message[302]: Register in operand not in bank 0. Ensure that bank bits are correct.
0180 0086      00555      MOVWF    TRISB
0181 1283      00556      BCF      STATUS,RP0        ;Point to BANK 0
0182 0BAA      00557      DECFSZ   cc, F            ;Step-up time units * 256
0183 2933      00558      GOTO     Inc_Time
00559
0184           00560      Task_7 ;Task 7 - Output Highest Level Indication on LED

```

```

0184 1DA7      00561      BTFSS    LED_Mode,LED_B    ;Is LED active ?
0185 2987      00562      GOTO     Task_8
0186 2039      00563      CALL    Do_LED            ;Handle LED timing
                                00564
0187          00565 Task_8 ;Task #8 - 5 Second Serial Input Lack of Activity Timer
0187 1D25      00566      BTFSS    T_B,T_5_S_B      ;5 Sec Timer Active ?
0188 2996      00567      GOTO     Task_9
0189 0AAD      00568      INCF    T_5_S_CO, F      ;Inc Counter - Time Unit = 131072 uS
018A 3026      00569      MOVLW   H'26'           ;Check T_5_S_CO if time
018B 022D      00570      SUBWF   T_5_S_CO,W
018C 1D03      00571      BTFSS    STATUS,Z
018D 2996      00572      GOTO     Task_9
018E 01AD      00573      CLRWF   T_5_S_CO        ;Reset T_5_S_CO
018F 308F      00574      MOVLW   LED_ON_MODE     ;Highest Level Indicator output
0190 00A7      00575      MOVWF   LED_Mode
0191 1F25      00576      BTFSS    T_B,S_5_S_B      ;Check if Lost Data Error
0192 1226      00577      BCF     FLAGS,S_5_S_Overflow
0193 1B25      00578      BTFSC   T_B,S_5_S_B
0194 1626      00579      BSF     FLAGS,S_5_S_Overflow
0195 1725      00580      BSF     T_B,S_5_S_B      ;Send notice of 5 seconds of inaction
                                00581
0196          00582 Task_9 ;Task #9 - 5 Min. Lack of Severe Error from Sensors Reset Timer
0196 1DA5      00583      BTFSS    T_B,T_5_M_B      ;5 Min Timer Active ?
0197 29A7      00584      GOTO     Task_A
0198 0AAB      00585      INCF    T_5_M_LO, F      ;Inc LO Counter; Time Unit = 131072 uS
0199 1903      00586      BTFSC   STATUS,Z        ;See if carry needs to be passed on ?
019A 0AAC      00587      INCF    T_5_M_HI, F      ;Inc HI Counter; Time Unit = 131072 uS
019B 3008      00588      MOVLW   H'08'           ;#2288< Check T_5_M_HI if time
019C 022C      00589      SUBWF   T_5_M_HI,W
019D 1D03      00590      BTFSS    STATUS,Z
019E 29A7      00591      GOTO     Task_A
019F 30F0      00592      MOVLW   H'F0'           ;#2288> Check T_5_M_LO if time
01A0 022B      00593      SUBWF   T_5_M_LO,W
01A1 1D03      00594      BTFSS    STATUS,Z
01A2 29A7      00595      GOTO     Task_A
01A3 01AB      00596      CLRWF   T_5_M_LO        ;Reset T_5_M_LO
01A4 01AC      00597      CLRWF   T_5_M_HI        ;Reset T_5_M_HI
01A5 3008      00598      MOVLW   LED_OFF_MODE    ;Lowest Level Indicator output
01A6 00A7      00599      MOVWF   LED_Mode
01A7          00600 Task_A
01A7 2933      00601      GOTO     Inc_Time        ;Loop Forever
                                00602
                                00603 ;**** Determine the Highest Error Level & Start Task #7
01A8          00604 D_H_E_L
01A8 3007      00605      MOVLW   H'07'           ;Check top 7 bits
01A9 00A0      00606      MOVWF   tmp
01AA 0834      00607      MOVF    Old_RB,W        ;Get copy of 7 debounced Sensor Input
01AB 00A1      00608      MOVWF   tmp
01AC 0DA1      00609      RLF     tmp, F          ;Put top bit into C bit
01AD 1803      00610      BTFSC   STATUS,C        ;Check if C bit is set
01AE 29B4      00611      GOTO     _0072
01AF 0BA0      00612      DECFSZ  tmp, F          ;Continue to check lesser bits
01B0 29AC      00613      GOTO     _0070
01B1 0806      00614      MOVF    PORTB,W        ;Restore current value of RB
01B2 00A1      00615      MOVWF   tmp
01B3 0008      00616      RETURN
01B4 0827      00617      MOVF    LED_Mode,W      ;Get current Level Indicator
01B5 3907      00618      ANDLW   H'07'           ;Get only " "
01B6 00A1      00619      MOVWF   tmp            ;Store into a temporary register
01B7 0820      00620      MOVF    tmp,W          ;Check if already at this Level
01B8 0221      00621      SUBWF   tmp,W
01B9 1803      00622      BTFSC   STATUS,C
01BA 29B1      00623      GOTO     _0071
01BB 3088      00624      MOVLW   H'88'           ;Start to build LED_Mode
01BC 0420      00625      IORWF   tmp,W          ;Put new Level Indicator into reg
01BD 00A7      00626      MOVWF   LED_Mode        ;Store new LED Mode

```

```

01BE 29B1          00627          GOTO          _0071
                   00628
                   00629 ;*****          Clear Registers 20-7Fh, A0-C0
01BF              00630 Clear_Regs
01BF 307F          00631          MOVLW        H'7F'          ;First regs to clear in Bank 0
01C0 0084          00632          MOVWF        FSR
01C1 0180          00633 Loop_C1  CLRf        INDF          ;Clear reg
01C2 0384          00634          DECF        FSR, F          ;point to next reg to clear
01C3 3020          00635          MOVLW        H'20'          ;Dec temp, jump if not done
01C4 0204          00636          SUBWF        FSR,W
01C5 1803          00637          BTFSC       STATUS,C
01C6 29C1          00638          GOTO        Loop_C1
                   00639
01C7 30C0          00640          MOVLW        H'C0'          ;First regs to clear in Bank 1
01C8 0084          00641          MOVWF        FSR
01C9 0180          00642 Loop_C2  CLRf        INDF          ;Clear reg
01CA 0384          00643          DECF        FSR, F          ;point to next reg to clear
01CB 30A0          00644          MOVLW        H'A0'          ;Dec temp, jump if not done
01CC 0204          00645          SUBWF        FSR,W
01CD 1803          00646          BTFSC       STATUS,C
01CE 29C9          00647          GOTO        Loop_C2
01CF 0184          00648          CLRF        FSR          ;Lastly clear FSR reg
01D0 0008          00649          RETURN
                   00650
                   00651 ;*****          TMR0 IRS - Set Time_Bit for background tasks
01D1              00652 Do_Inc_Time
01D1 16A6          00653          BSF         FLAGS,Time_Bit ;Tell background tasks of overflow
01D2 110B          00654          BCF         INTCON,T0IF    ;Clear for next overflow
01D3 0008          00655          RETURN
                   00656
                   00657 ;*****          Handle Interrupts Here
01D4              00658 Interrupt
01D4 00A2          00659 PUSH:    MOVWF        Temp_W
01D5 0E03          00660          SWAPF       STATUS,W
01D6 00A3          00661          MOVWF        Temp_Stat
01D7 0804          00662          MOVF         FSR,W
01D8 00A4          00663          MOVWF        Temp_FSR
01D9 1283          00664          BCF         STATUS,RP0    ;Point to BANK 0 - Very IMPORTANT !!!!!
                   00665
01DA 188C          00666          BTFSC       PIR1,TMR2IF
01DB 2005          00667          CALL        Do_OState    ;Go Do Task #1 - all states
                   00668
01DC 18A5          00669          BTFSC       T_B,IState1_B ;INTF will set even if INTE is cleared
01DD 29E0          00670          GOTO        I1
01DE 188B          00671          BTFSC       INTCON,INTF
01DF 2097          00672          CALL        Do_I1State    ;Go Do Task #2 - 0 state only
01E0              00673 I1:
01E0 180C          00674          BTFSC       PIR1,TMR1IF
01E1 2097          00675          CALL        Do_I1State    ;Go Do Task #2 - 1-B states
                   00676
01E2 190B          00677          BTFSC       INTCON,T0IF
01E3 21D1          00678          CALL        Do_Inc_Time    ;Go Inc Time_Bit every 512uS
                   00679
01E4 0824          00680 POP:    MOVF         Temp_FSR,W
01E5 0084          00681          MOVWF        FSR
01E6 0E23          00682          SWAPF       Temp_Stat,W
01E7 0083          00683          MOVWF        STATUS
01E8 0EA2          00684          SWAPF       Temp_W, F
01E9 0E22          00685          SWAPF       Temp_W,W
01EA 0009          00686          RETFIE      ;Return from Interrupt
                   00687
                   00688          END

```

AN585

MEMORY USAGE MAP ('X' = Used, '-' = Unused)

```
0000 : X--XXXXXXXXXXXX XXXXXXXXXXXXXXX XXXXXXXXXXXXXXX XXXXXXXXXXXXXXX
0040 : XXXXXXXXXXXXXXX XXXXXXXXXXXXXXX XXXXXXXXXXXXXXX XXXXXXXXXXXXXXX
0080 : XXXXXXXXXXXXXXX XXXXXXXXXXXXXXX XXXXXXXXXXXXXXX XXXXXXXXXXXXXXX
00C0 : XXXXXXXXXXXXXXX XXXXXXXXXXXXXXX XXXXXXXXXXXXXXX XXXXXXXXXXXXXXX
0100 : XXXXXXXXXXXXXXX XXXXXXXXXXXXXXX XXXXXXXXXXXXXXX XXXXXXXXXXXXXXX
0140 : XXXXXXXXXXXXXXX XXXXXXXXXXXXXXX XXXXXXXXXXXXXXX XXXXXXXXXXXXXXX
0180 : XXXXXXXXXXXXXXX XXXXXXXXXXXXXXX XXXXXXXXXXXXXXX XXXXXXXXXXXXXXX
01C0 : XXXXXXXXXXXXXXX XXXXXXXXXXXXXXX XXXXXXXXXXX-- --
```

All other memory blocks unused.

Program Memory Words Used: 488
Program Memory Words Free: 1560

Errors : 0
Warnings : 0 reported, 0 suppressed
Messages : 19 reported, 0 suppressed

Note the following details of the code protection feature on PICmicro® MCUs.

- The PICmicro family meets the specifications contained in the Microchip Data Sheet.
- Microchip believes that its family of PICmicro microcontrollers is one of the most secure products of its kind on the market today, when used in the intended manner and under normal conditions.
- There are dishonest and possibly illegal methods used to breach the code protection feature. All of these methods, to our knowledge, require using the PICmicro microcontroller in a manner outside the operating specifications contained in the data sheet. The person doing so may be engaged in theft of intellectual property.
- Microchip is willing to work with the customer who is concerned about the integrity of their code.
- Neither Microchip nor any other semiconductor manufacturer can guarantee the security of their code. Code protection does not mean that we are guaranteeing the product as “unbreakable”.
- Code protection is constantly evolving. We at Microchip are committed to continuously improving the code protection features of our product.

If you have any further questions about this matter, please contact the local sales office nearest to you.

Information contained in this publication regarding device applications and the like is intended through suggestion only and may be superseded by updates. It is your responsibility to ensure that your application meets with your specifications. No representation or warranty is given and no liability is assumed by Microchip Technology Incorporated with respect to the accuracy or use of such information, or infringement of patents or other intellectual property rights arising from such use or otherwise. Use of Microchip's products as critical components in life support systems is not authorized except with express written approval by Microchip. No licenses are conveyed, implicitly or otherwise, under any intellectual property rights.

Trademarks

The Microchip name and logo, the Microchip logo, FilterLab, KEELOQ, microID, MPLAB, PIC, PICmicro, PICMASTER, PICSTART, PRO MATE, SEEVAL and The Embedded Control Solutions Company are registered trademarks of Microchip Technology Incorporated in the U.S.A. and other countries.

dsPIC, ECONOMONITOR, FanSense, FlexROM, fuzzyLAB, In-Circuit Serial Programming, ICSP, ICEPIC, microPort, Migratable Memory, MPASM, MPLIB, MPLINK, MPSIM, MXDEV, PICC, PICDEM, PICDEM.net, rPIC, Select Mode and Total Endurance are trademarks of Microchip Technology Incorporated in the U.S.A.

Serialized Quick Turn Programming (SQTP) is a service mark of Microchip Technology Incorporated in the U.S.A.

All other trademarks mentioned herein are property of their respective companies.

© 2002, Microchip Technology Incorporated, Printed in the U.S.A., All Rights Reserved.

 Printed on recycled paper.

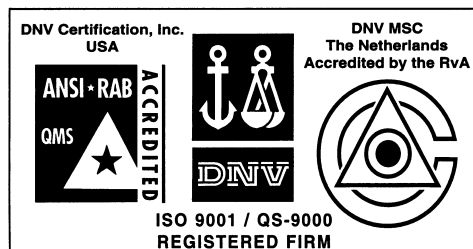

Microchip received QS-9000 quality system certification for its worldwide headquarters, design and wafer fabrication facilities in Chandler and Tempe, Arizona in July 1999. The Company's quality system processes and procedures are QS-9000 compliant for its PICmicro® 8-bit MCUs, KEELOQ® code hopping devices, Serial EEPROMs and microperipheral products. In addition, Microchip's quality system for the design and manufacture of development systems is ISO 9001 certified.



MICROCHIP

WORLDWIDE SALES AND SERVICE

AMERICAS

Corporate Office

2355 West Chandler Blvd.
Chandler, AZ 85224-6199
Tel: 480-792-7200 Fax: 480-792-7277
Technical Support: 480-792-7627
Web Address: <http://www.microchip.com>

Rocky Mountain

2355 West Chandler Blvd.
Chandler, AZ 85224-6199
Tel: 480-792-7966 Fax: 480-792-7456

Atlanta

500 Sugar Mill Road, Suite 200B
Atlanta, GA 30350
Tel: 770-640-0034 Fax: 770-640-0307

Boston

2 Lan Drive, Suite 120
Westford, MA 01886
Tel: 978-692-3848 Fax: 978-692-3821

Chicago

333 Pierce Road, Suite 180
Itasca, IL 60143
Tel: 630-285-0071 Fax: 630-285-0075

Dallas

4570 Westgrove Drive, Suite 160
Addison, TX 75001
Tel: 972-818-7423 Fax: 972-818-2924

Detroit

Tri-Atria Office Building
32255 Northwestern Highway, Suite 190
Farmington Hills, MI 48334
Tel: 248-538-2250 Fax: 248-538-2260

Kokomo

2767 S. Albright Road
Kokomo, Indiana 46902
Tel: 765-864-8360 Fax: 765-864-8387

Los Angeles

18201 Von Karman, Suite 1090
Irvine, CA 92612
Tel: 949-263-1888 Fax: 949-263-1338

New York

150 Motor Parkway, Suite 202
Hauppauge, NY 11788
Tel: 631-273-5305 Fax: 631-273-5335

San Jose

Microchip Technology Inc.
2107 North First Street, Suite 590
San Jose, CA 95131
Tel: 408-436-7950 Fax: 408-436-7955

Toronto

6285 Northam Drive, Suite 108
Mississauga, Ontario L4V 1X5, Canada
Tel: 905-673-0699 Fax: 905-673-6509

ASIA/PACIFIC

Australia

Microchip Technology Australia Pty Ltd
Suite 22, 41 Rawson Street
Epping 2121, NSW
Australia
Tel: 61-2-9868-6733 Fax: 61-2-9868-6755

China - Beijing

Microchip Technology Consulting (Shanghai)
Co., Ltd., Beijing Liaison Office
Unit 915
Bei Hai Wan Tai Bldg.
No. 6 Chaoyangmen Beidajie
Beijing, 100027, No. China
Tel: 86-10-85282100 Fax: 86-10-85282104

China - Chengdu

Microchip Technology Consulting (Shanghai)
Co., Ltd., Chengdu Liaison Office
Rm. 2401, 24th Floor,
Ming Xing Financial Tower
No. 88 TIDU Street
Chengdu 610016, China
Tel: 86-28-6766200 Fax: 86-28-6766599

China - Fuzhou

Microchip Technology Consulting (Shanghai)
Co., Ltd., Fuzhou Liaison Office
Unit 28F, World Trade Plaza
No. 71 Wusi Road
Fuzhou 350001, China
Tel: 86-591-7503506 Fax: 86-591-7503521

China - Shanghai

Microchip Technology Consulting (Shanghai)
Co., Ltd.
Room 701, Bldg. B
Far East International Plaza
No. 317 Xian Xia Road
Shanghai, 200051
Tel: 86-21-6275-5700 Fax: 86-21-6275-5060

China - Shenzhen

Microchip Technology Consulting (Shanghai)
Co., Ltd., Shenzhen Liaison Office
Rm. 1315, 13/F, Shenzhen Kerry Centre,
Renminnan Lu
Shenzhen 518001, China
Tel: 86-755-2350361 Fax: 86-755-2366086

Hong Kong

Microchip Technology Hongkong Ltd.
Unit 901-6, Tower 2, Metroplaza
223 Hing Fong Road
Kwai Fong, N.T., Hong Kong
Tel: 852-2401-1200 Fax: 852-2401-3431

India

Microchip Technology Inc.
India Liaison Office
Divyasree Chambers
1 Floor, Wing A (A3/A4)
No. 11, O'Shaugnessey Road
Bangalore, 560 025, India
Tel: 91-80-2290061 Fax: 91-80-2290062

Japan

Microchip Technology Japan K.K.
Benex S-1 6F
3-18-20, Shinyokohama
Kohoku-Ku, Yokohama-shi
Kanagawa, 222-0033, Japan
Tel: 81-45-471- 6166 Fax: 81-45-471-6122

Korea

Microchip Technology Korea
168-1, Youngbo Bldg. 3 Floor
Samsung-Dong, Kangnam-Ku
Seoul, Korea 135-882
Tel: 82-2-554-7200 Fax: 82-2-558-5934

Singapore

Microchip Technology Singapore Pte Ltd.
200 Middle Road
#07-02 Prime Centre
Singapore, 188980
Tel: 65-334-8870 Fax: 65-334-8850

Taiwan

Microchip Technology Taiwan
11F-3, No. 207
Tung Hua North Road
Taipei, 105, Taiwan
Tel: 886-2-2717-7175 Fax: 886-2-2545-0139

EUROPE

Denmark

Microchip Technology Nordic ApS
Regus Business Centre
Lautrup høj 1-3
Ballerup DK-2750 Denmark
Tel: 45 4420 9895 Fax: 45 4420 9910

France

Microchip Technology SARL
Parc d'Activite du Moulin de Massy
43 Rue du Saule Trapu
Batiment A - ler Etage
91300 Massy, France
Tel: 33-1-69-53-63-20 Fax: 33-1-69-30-90-79

Germany

Microchip Technology GmbH
Gustav-Heinemann Ring 125
D-81739 Munich, Germany
Tel: 49-89-627-144 0 Fax: 49-89-627-144-44

Italy

Microchip Technology SRL
Centro Direzionale Colleoni
Palazzo Taurus 1 V. Le Colleoni 1
20041 Agrate Brianza
Milan, Italy
Tel: 39-039-65791-1 Fax: 39-039-6899883

United Kingdom

Arizona Microchip Technology Ltd.
505 Eskdale Road
Winnersh Triangle
Wokingham
Berkshire, England RG41 5TU
Tel: 44 118 921 5869 Fax: 44-118 921-5820

01/18/02